



STGB10NB37LZ

N-CHANNEL CLAMPED 10A D²PAK INTERNALLY CLAMPED PowerMESH™ IGBT

TYPE	V _{CES}	V _{CE(sat)}	I _C
STGB10NB37LZ	CLAMPED	< 1.8 V	10 A

- POLYSILICON GATE VOLTAGE DRIVEN
- LOW THRESHOLD VOLTAGE
- LOW ON-VOLTAGE DROP
- HIGH CURRENT CAPABILITY
- HIGH VOLTAGE CLAMPING FEATURE
- SURFACE-MOUNTING D²PAK (TO-263)
POWER PACKAGE IN TUBE (NO SUFFIX)
OR IN TAPE & REEL (SUFFIX "T4")

DESCRIPTION

Using the latest high voltage technology based on patented strip layout, SGS-Thomson has designed an advanced family of IGBTs with outstanding performances.

The built in collector-gate zener exhibits a very precise active clamping while the gate-emitter zener supplies an ESD protection.

APPLICATIONS

- AUTOMOTIVE IGNITION

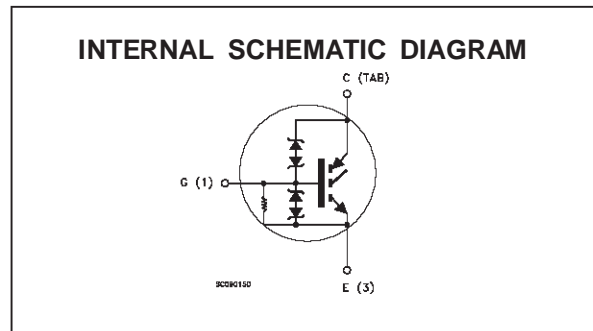
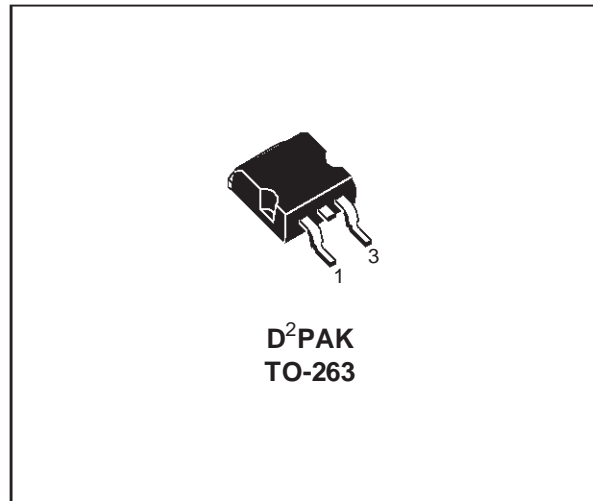

ABSOLUTE MAXIMUM RATINGS

Symbol	Parameter	Value	Unit
V _{CES}	Collector-Emitter Voltage (V _{GS} = 0)	CLAMPED	V
V _{ECR}	Reverse Battery Protection	18	V
V _{GE}	Gate-Emitter Voltage	CLAMPED	V
I _C	Collector Current (continuous) at T _c = 25 °C	20	A
I _C	Collector Current (continuous) at T _c = 100 °C	20	A
I _{CM} (•)	Collector Current (pulsed)	60	A
P _{tot}	Total Dissipation at T _c = 25 °C	125	W
	Derating Factor	0.83	W/°C
E _{SD}	ESD (Human Body Model)	4	KV
T _{stg}	Storage Temperature	-65 to 175	°C
T _j	Max. Operating Junction Temperature	175	°C

(•) Pulse width limited by safe operating area

STGB10NB37LZ

THERMAL DATA

$R_{thj-case}$	Thermal Resistance Junction-case	Max	1.2	$^{\circ}C/W$
$R_{thj-amb}$	Thermal Resistance Junction-ambient	Max	62.5	$^{\circ}C/W$
$R_{thc-sink}$	Thermal Resistance Case-sink	Typ	0.2	$^{\circ}C/W$

ELECTRICAL CHARACTERISTICS ($T_j = 25^{\circ}C$ unless otherwise specified)

OFF

Symbol	Parameter	Test Conditions	Min.	Typ.	Max.	Unit
$BV_{(CES)}$	Clamped Voltage	$I_C = 2\text{ mA}$ $T_j = -40\text{ to }150^{\circ}C$ $V_{GE} = 0$	375	400	425	V
$BV_{(ECR)}$	Emitter Collector Break-down Voltage	$I_C = 75\text{ mA}$ $T_j = -40\text{ to }150^{\circ}C$ $V_{GE} = 0$	18			V
BV_{GE}	Gate Emitter Break-down Voltage	$I_C = \pm 2\text{ mA}$ $T_j = -40\text{ to }150^{\circ}C$	12		16	V
I_{CES}	Collector cut-off Current ($V_{GE} = 0$)	$V_{CE} = 15\text{ V}$ $V_{GE} = 0$ $T_j = 150^{\circ}C$ $V_{CE} = 200\text{ V}$ $V_{GE} = 0$ $T_j = 150^{\circ}C$			10 100	μA μA
I_{GES}	Gate-Emitter Leakage Current ($V_{CE} = 0$)	$V_{GE} = \pm 10\text{ V}$ $V_{CE} = 0$			± 0.7	mA
R_{GE}	Gate Emitter Resistance			20		$K\Omega$

ON (*)

Symbol	Parameter	Test Conditions	Min.	Typ.	Max.	Unit
$V_{GE(th)}$	Gate Threshold Voltage	$V_{CE} = V_{GE}$ $I_C = 250\ \mu A$ $T_j = -40\text{ to }150^{\circ}C$	0.6		2.4	V
$V_{CE(SAT)}$	Collector-Emitter Saturation Voltage	$V_{GE} = 4.5\text{ V}$ $I_C = 10\text{ A}$ $T_j = 25^{\circ}C$ $V_{GE} = 4.5\text{ V}$ $I_C = 10\text{ A}$ $T_j = -40^{\circ}C$		1.2 1.3	1.8	V V
I_C	Collector Current	$V_{GE} = 4.5\text{ V}$ $V_{CE} = 9\text{ V}$	20			A

DYNAMIC

Symbol	Parameter	Test Conditions	Min.	Typ.	Max.	Unit
g_{fs}	Forward Transconductance	$V_{CE} = 25\text{ V}$ $I_C = 10\text{ A}$	10	18		S
C_{ies} C_{oes} C_{res}	Input Capacitance Output Capacitance Reverse Transfer Capacitance	$V_{CE} = 25\text{ V}$ $f = 1\text{ MHz}$ $V_{GE} = 0$		1250 103 18	1700 140 25	pF pF pF
Q_G	Gate Charge	$V_{CE} = 320\text{ V}$ $I_C = 10\text{ A}$ $V_{GE} = 5\text{ V}$		28		nC

FUNCTIONAL CHARACTERISTICS

Symbol	Parameter	Test Conditions	Min.	Typ.	Max.	Unit
I _L	Latching Current	V _{CLAMP} = 320 V V _{GE} = 5 V R _{G_{OFF}} = 1 KΩ T _C = 125 °C	20			A
U.I.S.	Unclamped Inductive Switching Current Functional Test	R _{G_{OFF}} =1 KΩ L =200 μH T _j = 125 °C R _{G_{OFF}} =1 KΩ L =3 mH T _{start} = 55 °C	15 12			A A
E _{AS}	Single Pulse Avalanche Energy	T _{start} = 55 °C T _{start} = 150 °C			215 150	mJ mJ
E _{AR}	Reverse Avalanche Energy	T _C = 125 °C duty cycle < 1% pulse width limited by t _{jmax}			10	mJ

ELECTRICAL CHARACTERISTICS (continued)

SWITCHING ON

Symbol	Parameter	Test Conditions	Min.	Typ.	Max.	Unit
t _{d(on)} t _r	Delay Time Rise Time	V _{CC} = 320 V I _C = 10 A V _{GE} = 5 V R _G = 1 KΩ		520 340		ns ns
(di/dt) _{on} E _{on}	Turn-on Current Slope Turn-on Switching Losses	V _{CC} = 320 V I _C = 10 A R _G = 1 KΩ V _{GE} = 5 V		17 180		A/μs μJ

SWITCHING OFF

Symbol	Parameter	Test Conditions	Min.	Typ.	Max.	Unit
t _c t _r (V _{off}) t _f t _d (off) E _{off} (**)	Cross-Over Time Off Voltage Rise Time Fall Time Off Voltage Delay Time Turn-off Switching Loss	V _{CLAMP} = 320 V I _C = 10 A R _{GE} = 1 KΩ V _{GE} = 5 V		4 2.2 1.5 14.8 4.0		μs μs μs μs mJ
t _c t _r (V _{off}) t _f t _d (off) E _{off} (**)	Cross-Over Time Off Voltage Rise Time Fall Time Off Voltage Delay Time Turn-off Switching Loss	V _{CLAMP} = 320 V I _C = 10 A R _{GE} = 1 KΩ V _{GE} = 5 V T _j = 125 °C		5.2 2.8 2 15.8 6.5		μs μs μs μs mJ

(*) Pulse width limited by safe operating area (**) Pulsed: Pulse duration = 300 ms, duty cycle 1.5 % (***)Losses Include Also The T tail (jedec Standardization)

Safe Operating Area

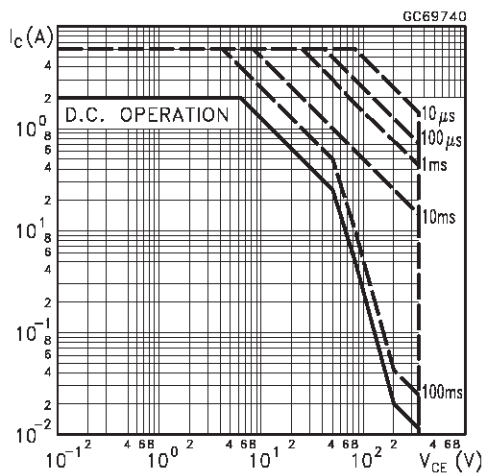

Thermal Impedance

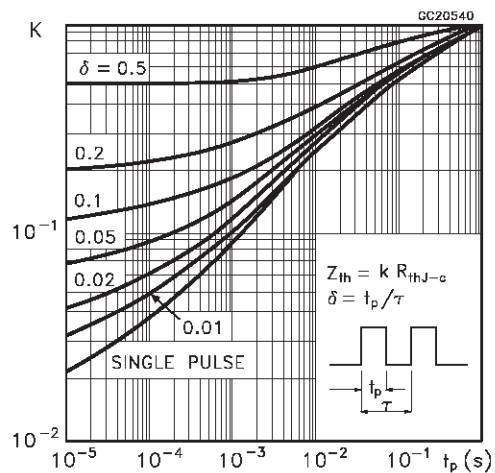

Output Characteristics

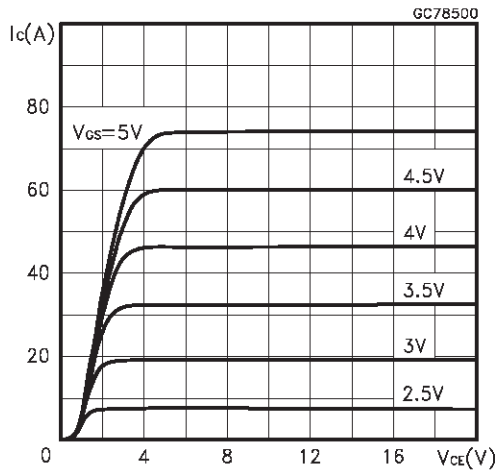

Transfer Characteristics

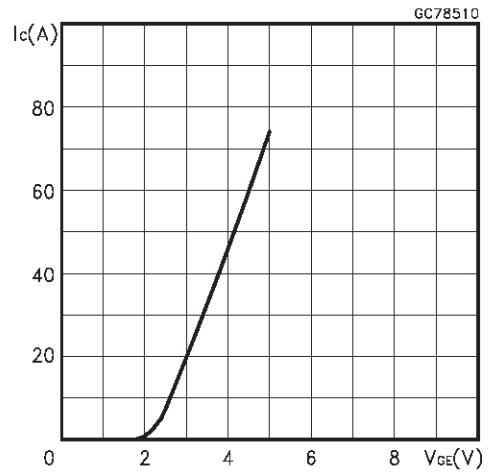

Normalized Gate Threshold Voltage vs Temperature

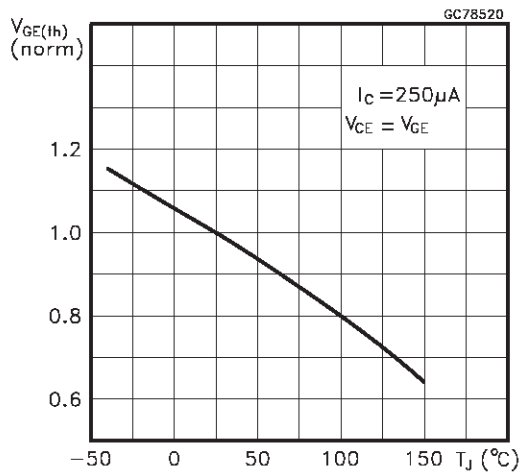

Transconductance

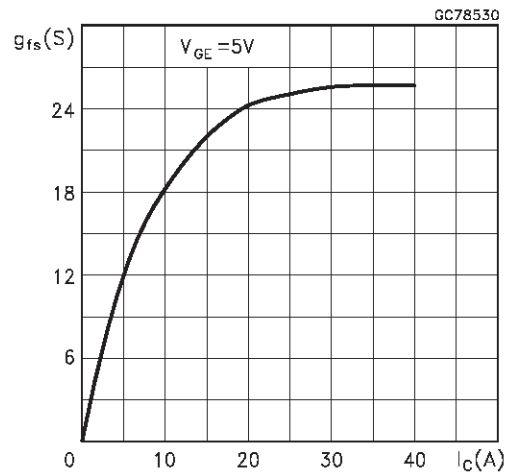

Collector-Emitter On Voltage vs Temperature

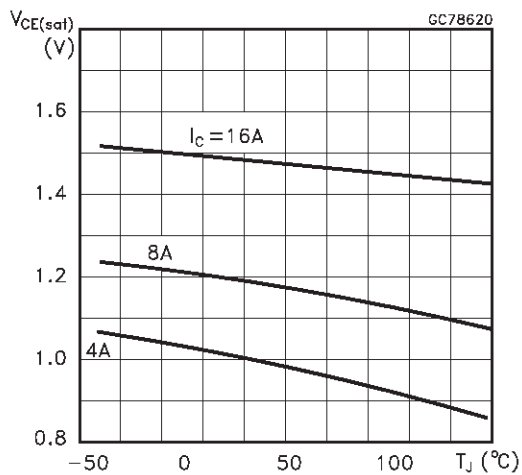

Collector-Emitter On Voltage vs Gate-Emitter Voltage

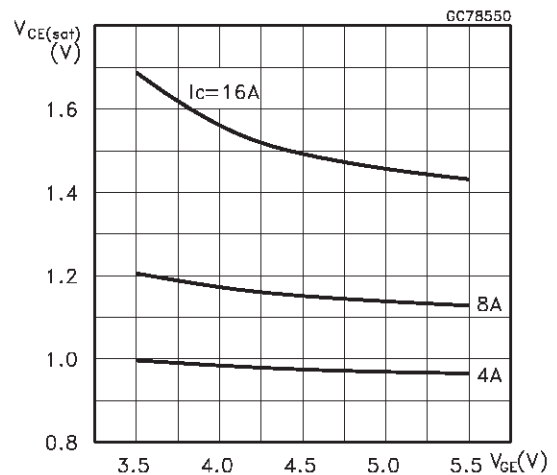

Capacitance Variations

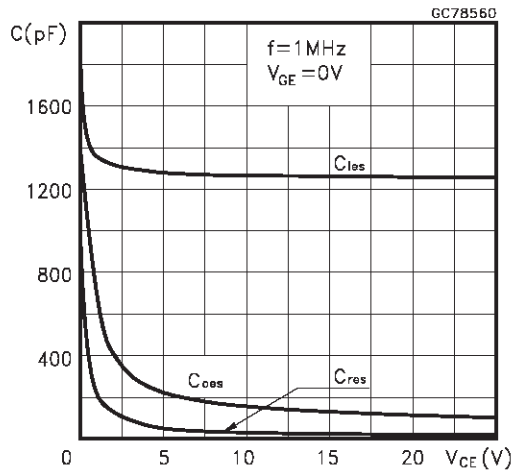

Gate Charge vs Gate-Emitter Voltage

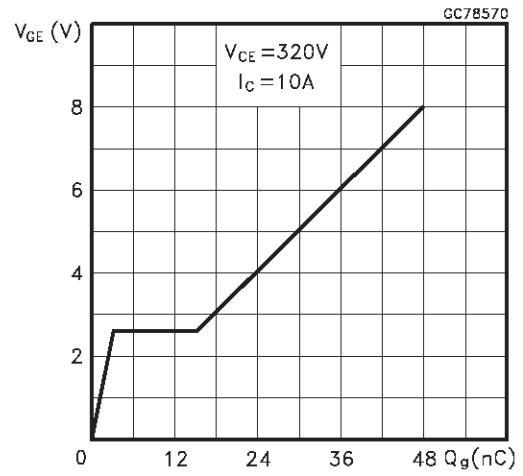

Off Losses vs Gate Resistance

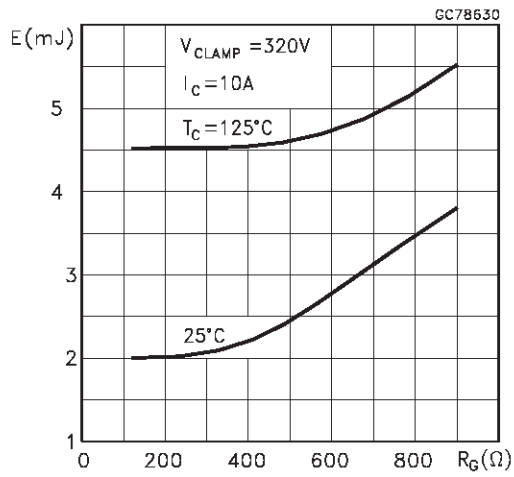

Off Losses vs Collector Current

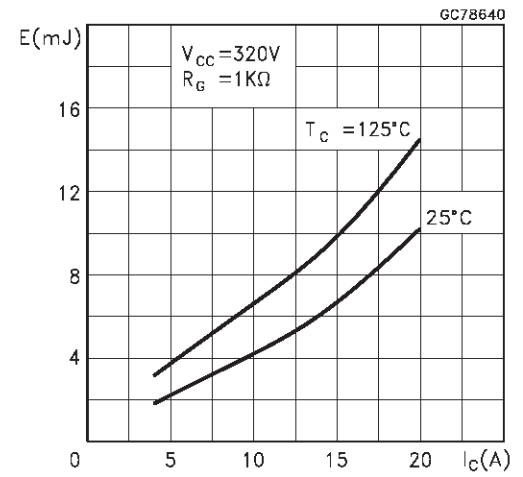

Break-down Voltage vs Temperature

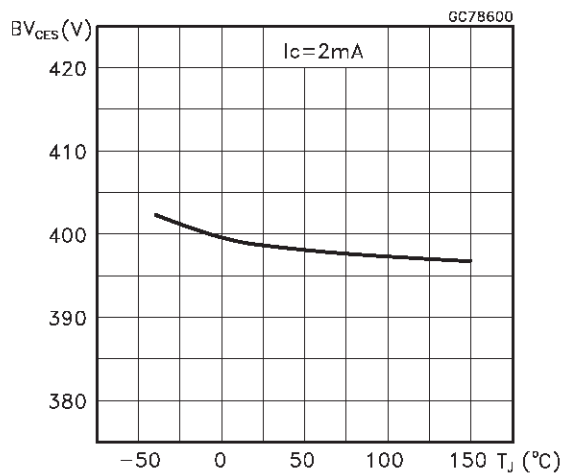

Clamping Voltage vs Gate Resistance

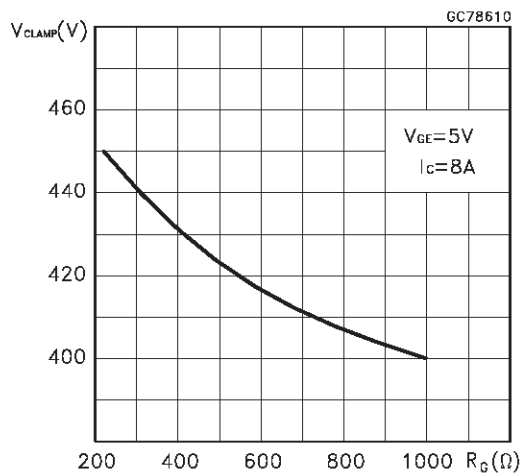

Fig. 1: Unclamped Inductive Load Test Circuit

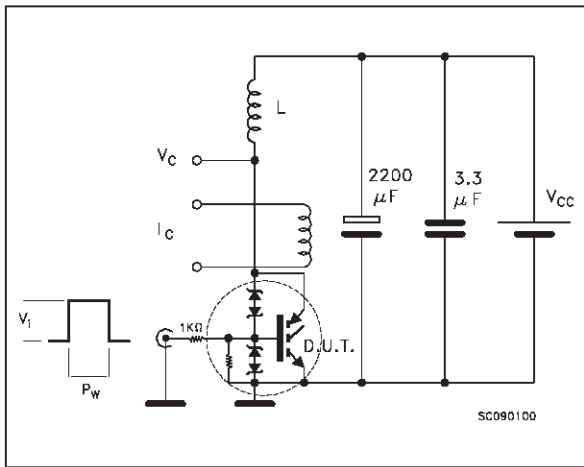

Fig. 2: Unclamped Inductive Waveform

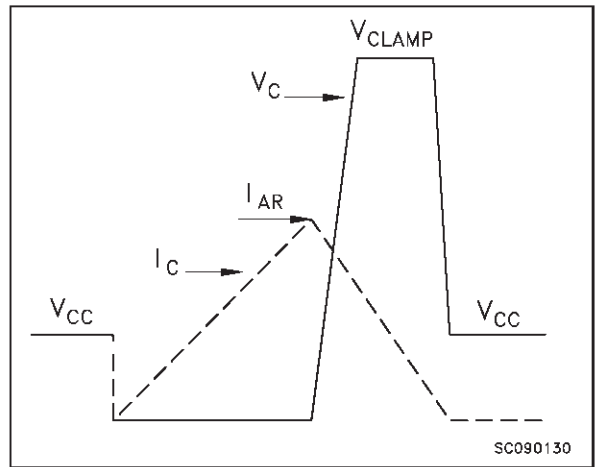

Fig. 3: Switching Times Test Circuits For Resistive Load

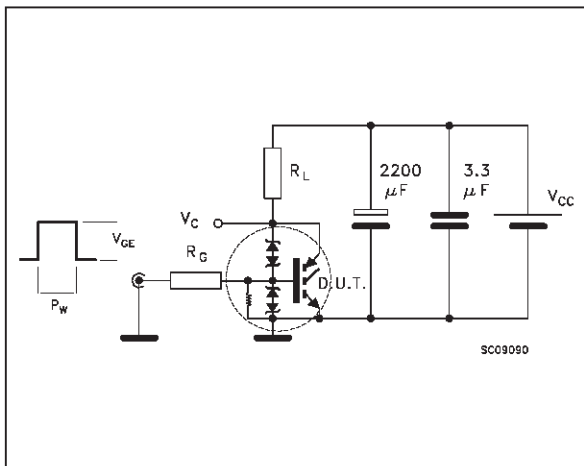

Fig. 4: Gate Charge test Circuit

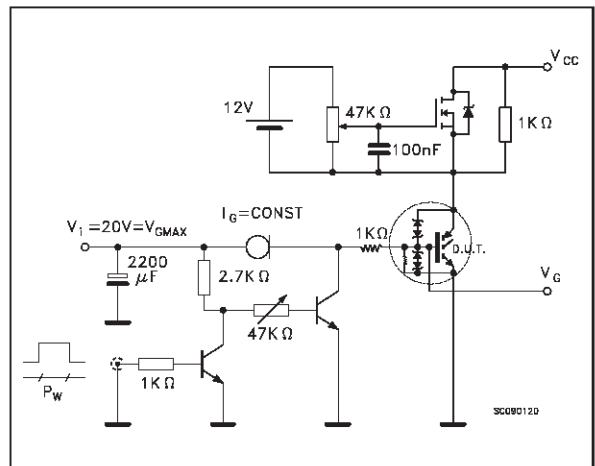
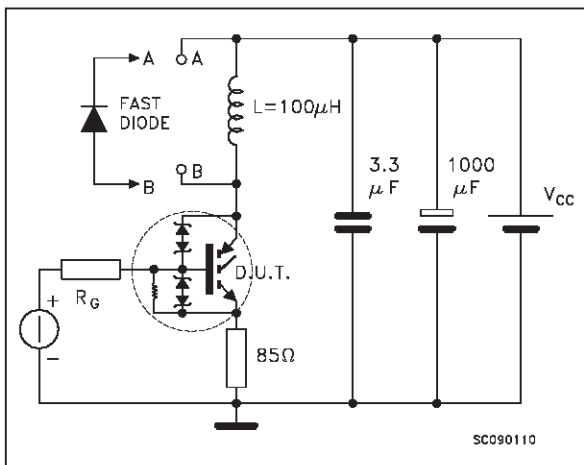
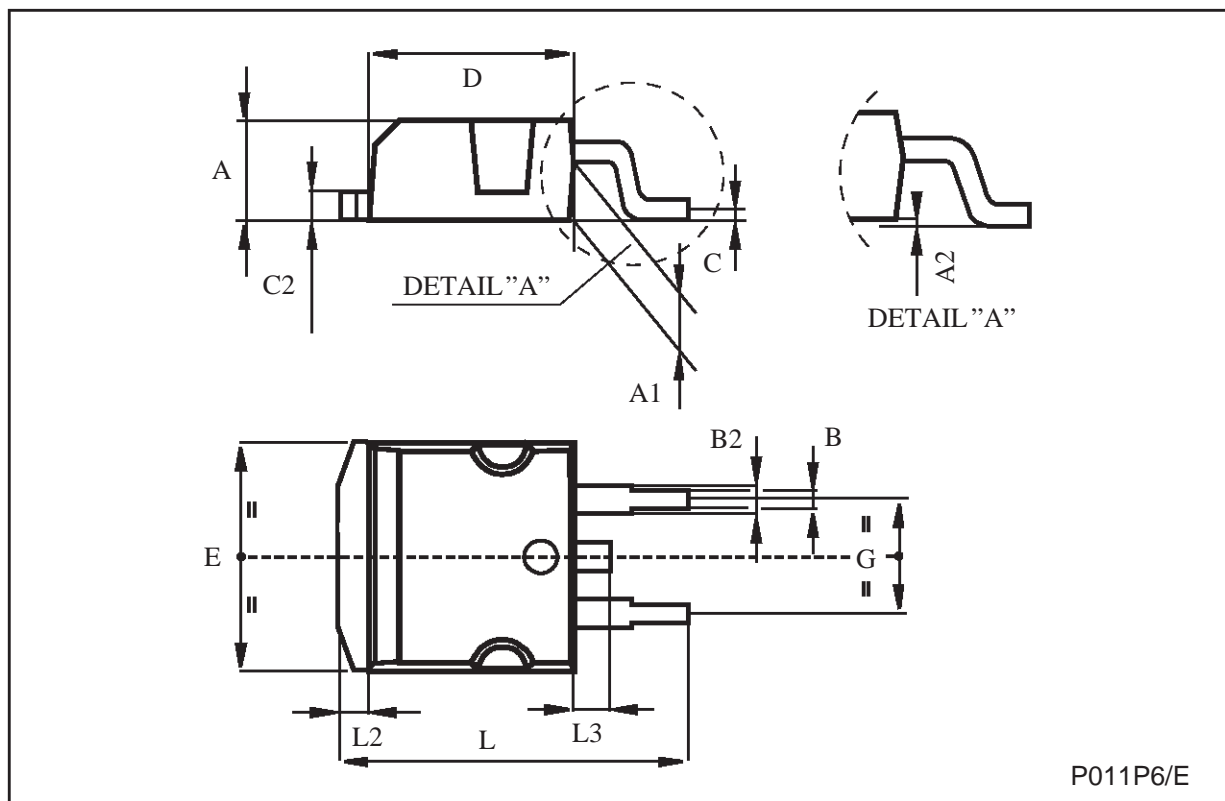

Fig. 5: Test Circuit For Inductive Load Switching And Diode Recovery Times



TO-263 (D²PAK) MECHANICAL DATA

DIM.	mm			inch		
	MIN.	TYP.	MAX.	MIN.	TYP.	MAX.
A	4.4		4.6	0.173		0.181
A1	2.49		2.69	0.098		0.106
B	0.7		0.93	0.027		0.036
B2	1.14		1.7	0.044		0.067
C	0.45		0.6	0.017		0.023
C2	1.21		1.36	0.047		0.053
D	8.95		9.35	0.352		0.368
E	10		10.4	0.393		0.409
G	4.88		5.28	0.192		0.208
L	15		15.85	0.590		0.624
L2	1.27		1.4	0.050		0.055
L3	1.4		1.75	0.055		0.068



Information furnished is believed to be accurate and reliable. However, STMicroelectronics assumes no responsibility for the consequences of use of such information nor for any infringement of patents or other rights of third parties which may result from its use. No license is granted by implication or otherwise under any patent or patent rights of STMicroelectronics. Specification mentioned in this publication are subject to change without notice. This publication supersedes and replaces all information previously supplied. STMicroelectronics products are not authorized for use as critical components in life support devices or systems without express written approval of STMicroelectronics.

The ST logo is a trademark of STMicroelectronics

© 1999 STMicroelectronics – Printed in Italy – All Rights Reserved
STMicroelectronics GROUP OF COMPANIES

Australia - Brazil - China - Finland - France - Germany - Hong Kong - India - Italy - Japan - Malaysia - Malta - Morocco -
Singapore - Spain - Sweden - Switzerland - United Kingdom - U.S.A.