

MAX4824PMB1 Peripheral Module

General Description

The MAX4824PMB1 peripheral module provides the necessary hardware to interface the MAX4824 8-channel relay driver to any system that utilizes Pmod™-compatible expansion ports configurable for GPIO communication. Each independent channel in the IC features a 2.7Ω (typ) on-resistance and is guaranteed to sink 70mA (min) of load current. A zener kickback-protection circuit significantly reduces recovery time in applications where switching speed is critical. When driving relays, a unique power-save mode allows relay current to be reduced to a level just above the relay hold-current threshold. This mode keeps the relay activated while significantly reducing the power consumption.

Refer to the MAX4824 IC data sheet for detailed information regarding operation of the IC.

Features

- ◆ Eight Independent Output Channels Capable of 70mA Sink Current
- ◆ Guaranteed 5Ω (max) R_{ON}
- ◆ Drive Eight Relays (or Other Loads) Independently
- ◆ 4-Bit Parallel Interface (SPI Version of IC also Available)
- ◆ 12-Pin Pmod-Compatible Connector (GPIO)
- ◆ Example Software Written in C for Portability
- ◆ RoHS Compliant
- ◆ Proven PCB Layout
- ◆ Fully Assembled and Tested

Ordering Information appears at end of data sheet.

MAX4824PMB1 Peripheral Module

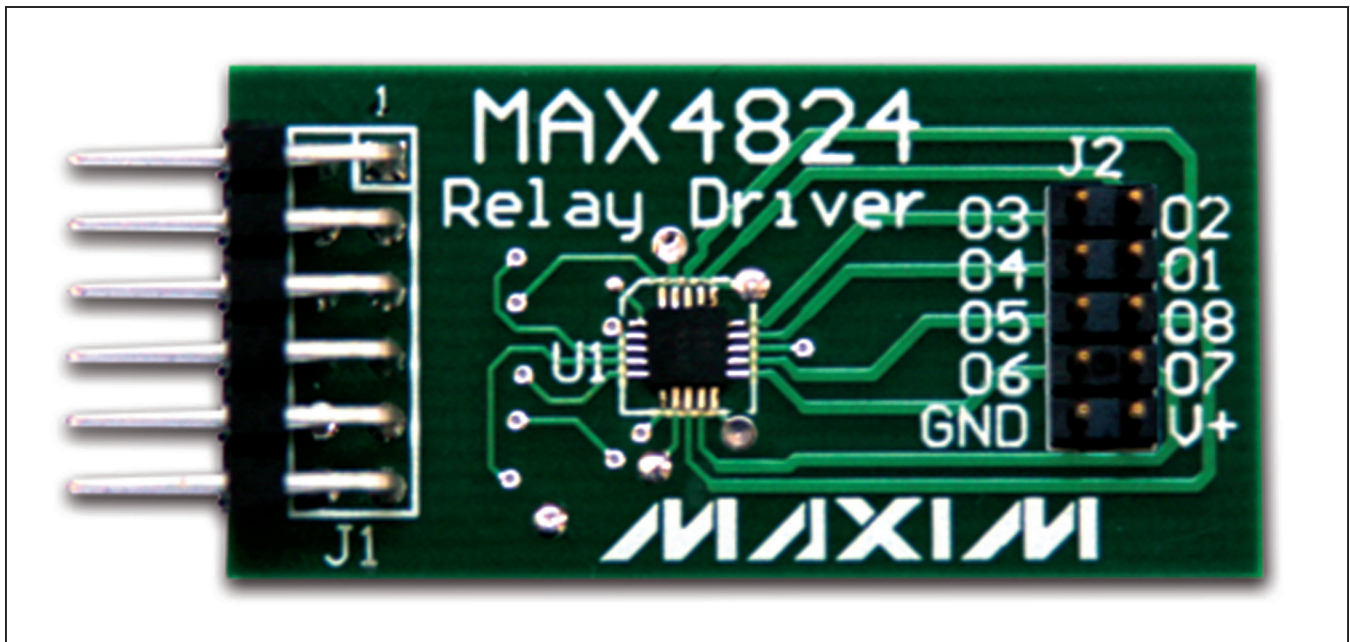

Pmod is a trademark of Digilent Inc.

MAX4824PMB1 Peripheral Module

Component List

DESIGNATION	QTY	DESCRIPTION
C1	1	1 μ F \pm 10%, 10V X7R ceramic capacitor (0603) TDK C1608X7R1A105K
C2	1	0.1 μ F \pm 10%, 16V X7R ceramic capacitor (0603) Murata GRM188R71C104KA01D
C3	1	2.2 μ F \pm 10%, 10V X5R ceramic capacitor (0603) TDK C1608X5R1A225K/0.80

DESIGNATION	QTY	DESCRIPTION
J1	1	12-pin (2 x 6) right-angle male header
J2	1	10-pin (2 x 5) straight male header
R1–R8	8	150 Ω \pm 5% resistors (0603)
U1	1	8-channel relay driver (20 TQFN-EP*) Maxim MAX4824ETP+
—	1	PCB: EPCB4824PM1

*EP = Exposed pad.

Component Suppliers

SUPPLIER	PHONE	WEBSITE
Murata Electronics North America, Inc.	770-436-1300	www.murata-northamerica.com
TDK Corp.	847-803-6100	www.component.tdk.com

Note: Indicate that you are using the MAX4824PMB1 when contacting these component suppliers.

Detailed Description

GPIO Interface

The MAX4824PMB1 peripheral module can interface to the host by plugging directly into a Pmod-compatible port (configured for GPIO) through connector J1.

J1 provides connection of the module to the Pmod host through an interface similar to the Pmod Type 1 standard recommended by Digilent, but incorporates a 12in connector with eight I/O pins. See Table 1.

The J2 connector provides the connection to the open-drain relay outputs. See Table 2.

Software and FPGA Code

Example software and drivers are available that execute directly without modification on several FPGA development boards, which support an integrated or synthesized microprocessor. These boards include the Digilent Nexys 3, Avnet LX9, and Avnet ZEDBoard, although other platforms can be added over time. Maxim provides complete Xilinx ISE projects containing HDL, Platform Studio, and SDK projects. In addition, a synthesized bit stream, ready for FPGA download, is provided for the demonstration application.

Table 1. Connector J1 (GPIO Communication)

PIN	SIGNAL	DESCRIPTION
1	$\overline{\text{CS}}$	Chip-select input. This active-low signal latches in the values of LVL and A2, A1, A0.
2	LVL	Level input. When latched by $\overline{\text{CS}}$, this signal determines whether a relay at a given address (A2, A1, A0) is active.
3	A1	A1 input. Relay address bit 1.
4	A0	A0 input. Relay address bit 0.
5	GND	Ground
6	VCC	Power supply
7	A2	A2 input. Relay address bit 2.
8	$\overline{\text{RES}}$	Reset Input. This active-low pin sets all eight relays inactive.
9	$\overline{\text{SET}}$	Set Input. This active-low pin sets all eight relays active.
10	PSAVE	Reduces coil current to relay hold-current threshold.
11	GND	Ground
12	VCC	Power supply

MAX4824PMB1 Peripheral Module

Table 2. Connector J2

PIN	SIGNAL	DESCRIPTION
1	OUT3	Open-drain output 1
2	OUT2	Open-drain output 2
3	OUT4	Open-drain output 3
4	OUT1	Open-drain output 4
5	OUT5	Open-drain output 5
6	OUT8	Open-drain output 6
7	OUT6	Open-drain output 7
8	OUT7	Open-drain output 8
9	GND	Ground
10	VCC	Power supply

The software project (for the SDK) contains several source files intended to accelerate customer evaluation and design. These include a base application (maximModules.c) that demonstrates module functionality and uses an API interface (maximDeviceSpecificUtilities.c) to set and access Maxim device functions within a specific module.

The source code is written in standard ANSI C format, and all API documentation including theory/operation, register description, and function prototypes are documented in the API interface file (maximDeviceSpecificUtilities.h & .c).

The complete software kit is available for download at www.maxim-ic.com. Quick start instructions are also available as a separate document.

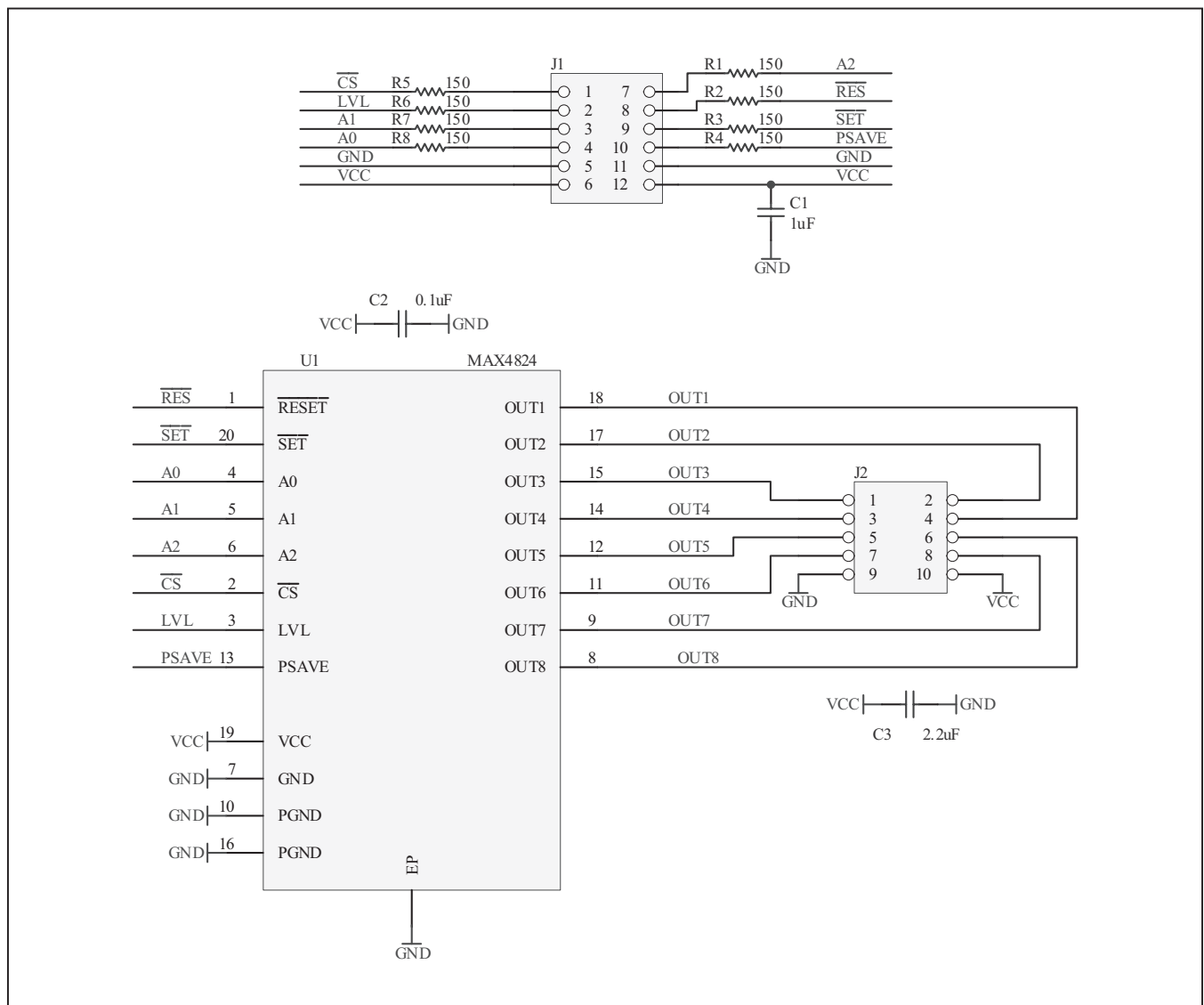

Figure 1. MAX4824PMB1 Peripheral Module Schematic

MAX4824PMB1 Peripheral Module

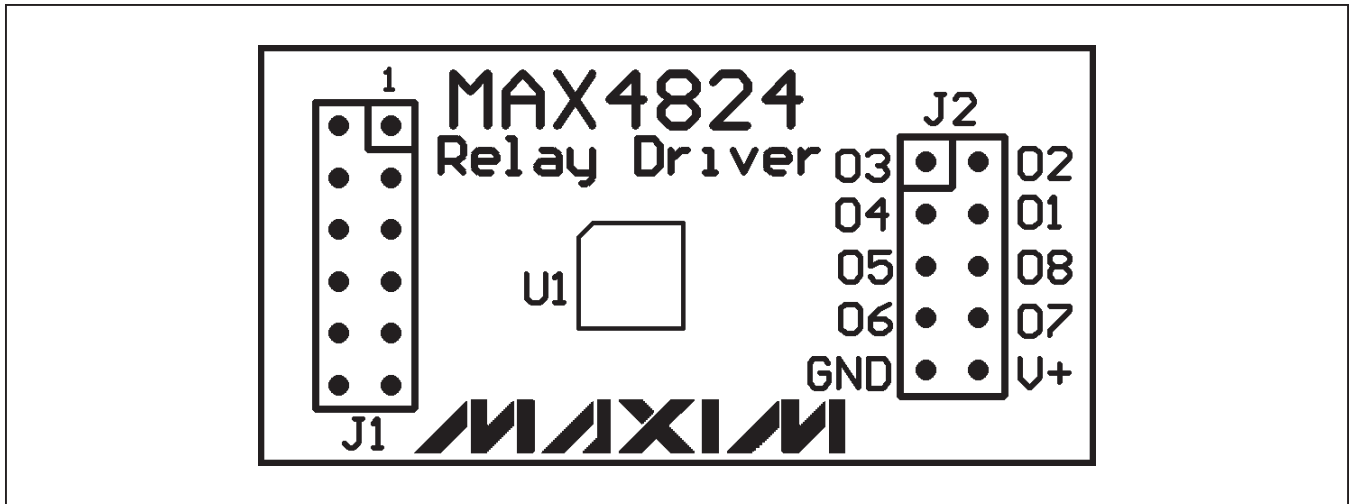

Figure 2. MAX4824PMB1 Peripheral Module Component Placement Guide—Component Side

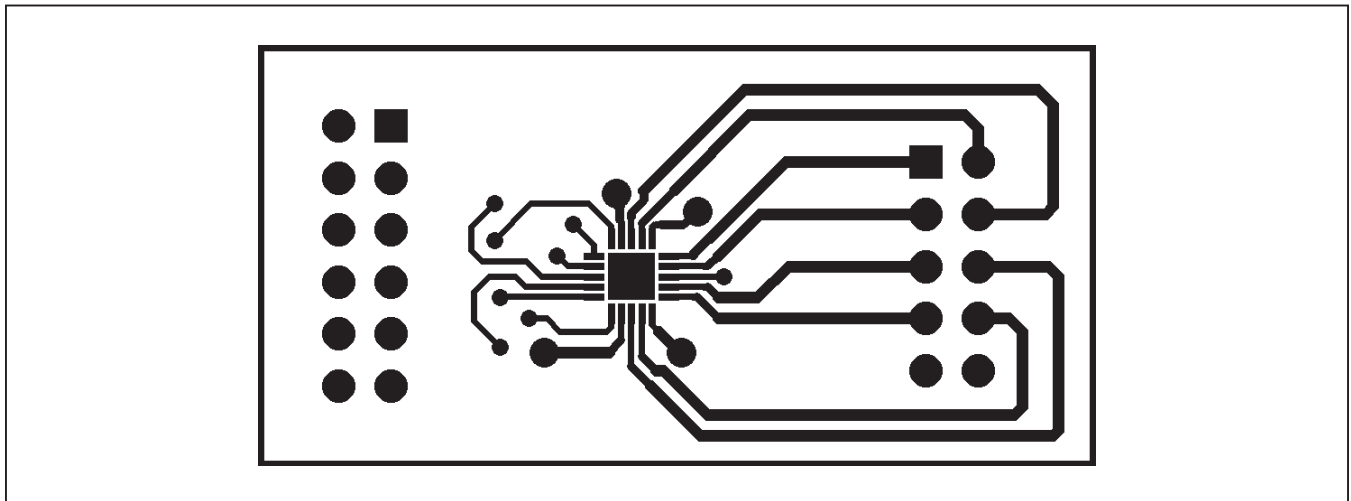

Figure 3. MAX4824PMB1 Peripheral Module PCB Layout—Component Side

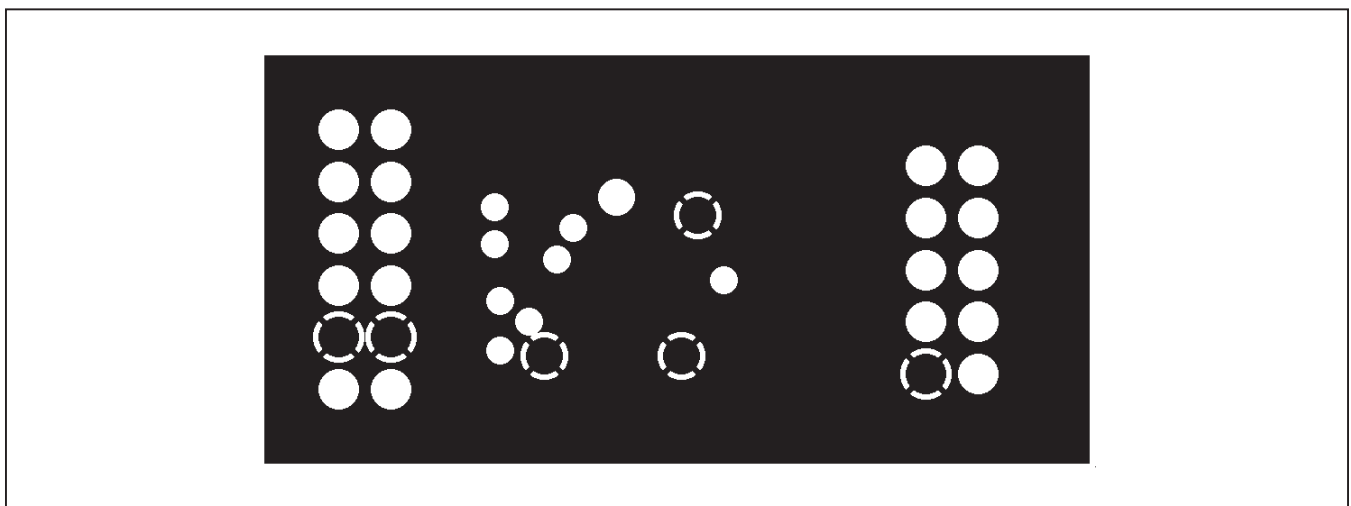

Figure 4. MAX4824PMB1 Peripheral Module PCB Layout—Inner Layer 1 (Ground)

MAX4824PMB1 Peripheral Module

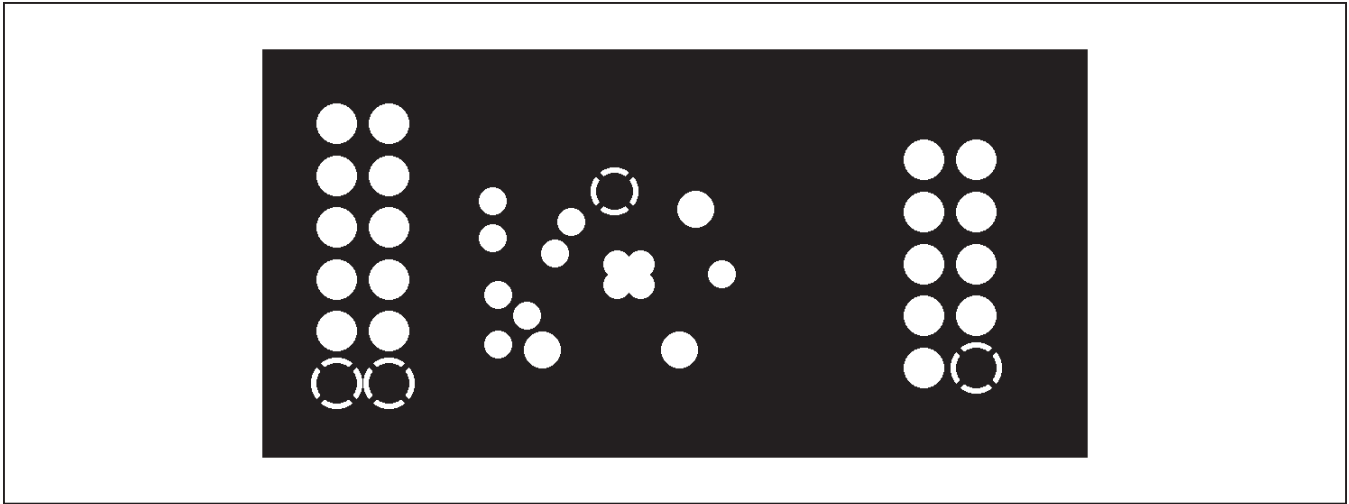

Figure 5. MAX4824PMB1 Peripheral Module PCB Layout—Inner Layer 2 (Power)

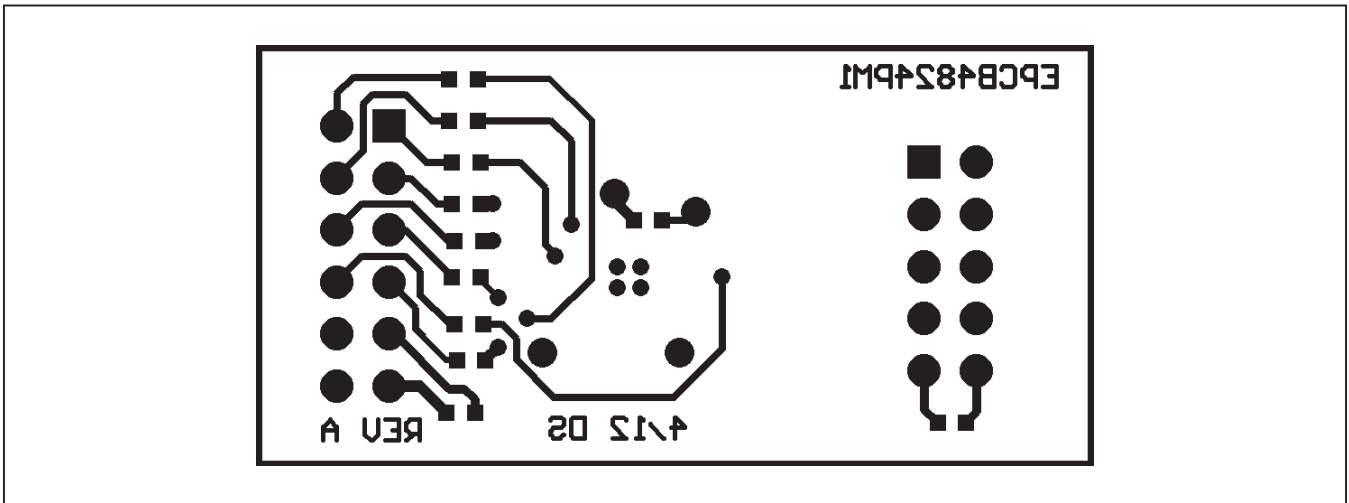

Figure 6. MAX4824PMB1 Peripheral Module PCB Layout—Solder Side

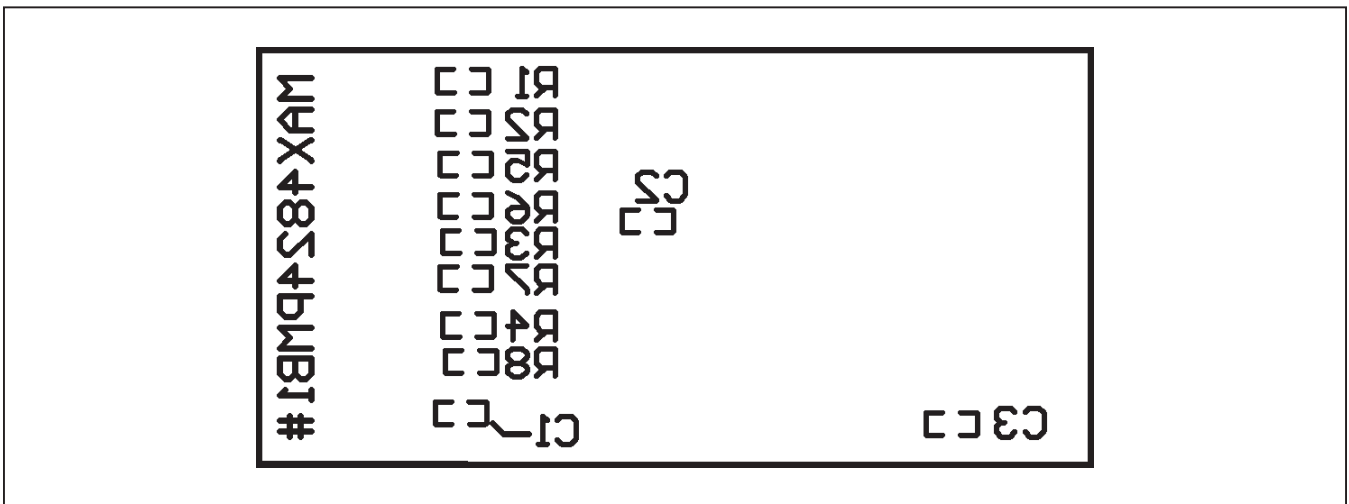

Figure 7. MAX4824PMB1 Peripheral Module Component Placement Guide—Solder Side

MAX4824PMB1 Peripheral Module

Ordering Information

PART	TYPE
MAX4824PMB1#	Peripheral Module

#Denotes RoHS compliant.

MAX4824PMB1 Peripheral Module

Revision History

REVISION NUMBER	REVISION DATE	DESCRIPTION	PAGES CHANGED
0	5/12	Initial release	—

Maxim cannot assume responsibility for use of any circuitry other than circuitry entirely embodied in a Maxim product. No circuit patent licenses are implied. Maxim reserves the right to change the circuitry and specifications without notice at any time.

Maxim Integrated Products, 120 San Gabriel Drive, Sunnyvale, CA 94086 408-737-7600 _____ 7

Mouser Electronics

Authorized Distributor

Click to View Pricing, Inventory, Delivery & Lifecycle Information:

[Analog Devices Inc.:](#)

[MAX4824PMB1#](#)