

# ECM-CX700

**3.5" VIA Eden V4 1 GHz/500MHz Micro Module with VGA,  
2-CH LVDS, DVI, TV-out, 5.1 CH Audio, Dual LAN, CF,  
PCI-104, 2 SATA, 2 COM, 4 USB 2.0 & 8-bit GPIO**

## User's Manual



**3<sup>rd</sup> Ed – 22 February 2008**

## FCC Statement



THIS DEVICE COMPLIES WITH PART 15 FCC RULES. OPERATION IS SUBJECT TO THE FOLLOWING TWO CONDITIONS:

(1) THIS DEVICE MAY NOT CAUSE HARMFUL INTERFERENCE.

(2) THIS DEVICE MUST ACCEPT ANY INTERFERENCE RECEIVED INCLUDING INTERFERENCE THAT MAY CAUSE UNDESIRE OPERATION.

THIS EQUIPMENT HAS BEEN TESTED AND FOUND TO COMPLY WITH THE LIMITS FOR A CLASS "A" DIGITAL DEVICE, PURSUANT TO PART 15 OF THE FCC RULES.

THESE LIMITS ARE DESIGNED TO PROVIDE REASONABLE PROTECTION AGAINST HARMFUL INTERFERENCE WHEN THE EQUIPMENT IS OPERATED IN A COMMERCIAL ENVIRONMENT. THIS EQUIPMENT GENERATES, USES, AND CAN RADIATE RADIO FREQUENCY ENERGY AND, IF NOT INSTALLED AND USED IN ACCORDANCE WITH THE INSTRUCTION MANUAL, MAY CAUSE HARMFUL INTERFERENCE TO RADIO COMMUNICATIONS.

OPERATION OF THIS EQUIPMENT IN A RESIDENTIAL AREA IS LIKELY TO CAUSE HARMFUL INTERFERENCE IN WHICH CASE THE USER WILL BE REQUIRED TO CORRECT THE INTERFERENCE AT HIS OWN EXPENSE.

## Notice

This guide is designed for experienced users to setup the system within the shortest time. For detailed information, please always refer to the electronic user's manual.

## Copyright Notice

Copyright © 2007 Avalue Technology Inc., ALL RIGHTS RESERVED.

No part of this document may be reproduced, copied, translated, or transmitted in any form or by any means, electronic or mechanical, for any purpose, without the prior written permission of the original manufacturer.

## Trademark Acknowledgement

Brand and product names are trademarks or registered trademarks of their respective owners.

## Disclaimer

Avalue Technology Inc. reserves the right to make changes, without notice, to any product, including circuits and/or software described or contained in this manual in order to improve design and/or performance. Avalue Technology assumes no responsibility or liability for the use of the described product(s), conveys no license or title under any patent, copyright, or masks work rights to these products, and makes no representations or warranties that these products are free from patent, copyright, or mask work right infringement, unless otherwise specified. Applications that are described in this manual are for illustration purposes only. Avalue Technology Inc. makes no representation or warranty that such application will be suitable for the specified use without further testing or modification.

## Life Support Policy

Avalue Technology's PRODUCTS ARE NOT FOR USE AS CRITICAL COMPONENTS IN LIFE SUPPORT DEVICES OR SYSTEMS WITHOUT THE PRIOR WRITTEN APPROVAL OF Avalue Technology Inc.

As used herein:

1. Life support devices or systems are devices or systems which, (a) are intended for surgical implant into body, or (b) support or sustain life and whose failure to perform, when properly used in accordance with instructions for use provided in the labeling, can be reasonably expected to result in significant injury to the user.
2. A critical component is any component of a life support device or system whose failure to perform can be reasonably expected to cause the failure of the life support device or system, or to affect its safety or effectiveness.

## A Message to the Customer

### *Avalue Customer Services*

Each and every Avalue's product is built to the most exacting specifications to ensure reliable performance in the harsh and demanding conditions typical of industrial environments. Whether your new Avalue device is destined for the laboratory or the factory floor, you can be assured that your product will provide the reliability and ease of operation for which the name Avalue has come to be known.

Your satisfaction is our primary concern. Here is a guide to Avalue's customer services. To ensure you get the full benefit of our services, please follow the instructions below carefully.

## ***Technical Support***

We want you to get the maximum performance from your products. So if you run into technical difficulties, we are here to help. For the most frequently asked questions, you can easily find answers in your product documentation. These answers are normally a lot more detailed than the ones we can give over the phone. So please consult the user's manual first.

To receive the latest version of the user's manual; please visit our Web site at:

<http://www.avalue.com.tw/>

If you still cannot find the answer, gather all the information or questions that apply to your problem, and with the product close at hand, call your dealer. Our dealers are well trained and ready to give you the support you need to get the most from your Avalue's products. In fact, most problems reported are minor and are able to be easily solved over the phone.

In addition, free technical support is available from Avalue's engineers every business day. We are always ready to give advice on application requirements or specific information on the installation and operation of any of our products. Please do not hesitate to call or e-mail us.

### **Headquarters**

#### **Avalue Technology Inc.**

7F, 228, Lian-cheng Road,  
Chung Ho City, Taipei,  
Taiwan

Tel : +886-2-8226-2345

Fax : +886-2-8226-2777

<http://www.avalue.com.tw>

E-mail: [service@avalue.com.tw](mailto:service@avalue.com.tw)

### **Europe Branch Office**

#### **Avalue Europe A/S**

Moelledalen 22C, 3140 Aalsgaarde,,  
Denmark

Tel : +45-7025-0310

Fax : +45-4975-5026

<http://www.avalue.com.tw>

E-mail: [service.europe@avalue.com.tw](mailto:service.europe@avalue.com.tw)

### **China Branch Office**

#### **Avalue Technology Shanghai Inc.**

Suite A, South 5F, No. 829,  
Yisan Road, Caohejing Hi-tech Park,  
Shanghai 200233, China

Tel : +86-21-5426-3399

Fax : +86-21-6495-0370

<http://www.avalue.com.tw>

E-mail: [service.china@avalue.com.tw](mailto:service.china@avalue.com.tw)

### **US Branch Office**

#### **Avalue Technology Inc.**

200 Tornillo Way, Suite 210,  
Tinton Falls, NJ 07712, USA

Tel: +1-732-578-0200

Fax: +1-732-578-0250

<http://www.avalue-usa.com>

E-mail: [service.usa@avalue-usa.com](mailto:service.usa@avalue-usa.com)

## ***Product Warranty***

Avalue warrants to you, the original purchaser, that each of its products will be free from defects in materials and workmanship for two years from the date of purchase.

This warranty does not apply to any products which have been repaired or altered by persons other than repair personnel authorized by Avalue, or which have been subject to misuse, abuse, accident or improper installation. Avalue assumes no liability under the terms of this warranty as a consequence of such events. Because of Avalue's high quality-control standards and rigorous testing, most of our customers never need to use our repair service. If any of Avalue's products is defective, it will be repaired or replaced at no charge during the warranty period. For out-of-warranty repairs, you will be billed according to the cost of replacement materials, service time, and freight. Please consult your dealer for more details. If you think you have a defective product, follow these steps:

1. Collect all the information about the problem encountered. (For example, CPU type and speed, Avalue's products model name, hardware & BIOS revision number, other hardware and software used, etc.) Note anything abnormal and list any on-screen messages you get when the problem occurs.
2. Call your dealer and describe the problem. Please have your manual, product, and any helpful information available.
3. If your product is diagnosed as defective, obtain an RMA (return material authorization) number from your dealer. This allows us to process your good return more quickly.
4. Carefully pack the defective product, a complete Repair and Replacement Order Card and a photocopy proof of purchase date (such as your sales receipt) in a shippable container. A product returned without proof of the purchase date is not eligible for warranty service.
5. Write the RMA number visibly on the outside of the package and ship it prepaid to your dealer.

# Contents

|  |           |
|--|-----------|
| <b>1. Getting Started.....</b>                             | <b>9</b>  |
| .....  | 9         |
| .....  | 9         |
| .....  | 10        |
| .....  | 11        |
| System Specifications .....                                | 12        |
| .....  | 14        |
| 1.6.1 Block Diagram .....                                  | 14        |
| 1.6.2 VIA CX700M.....                                      | 15        |
| 1.6.3 Realtek ALC883 AC'97 Codec.....                      | 18        |
| 1.6.4 VIA VT1211 Super I/O.....                            | 20        |
| 1.6.5 Ethernet-Realtek RTL8101L Ethernet Controller .....  | 22        |
| 1.6.6 Compact Flash Interface .....                        | 23        |
| <b>2. Hardware Configuration.....</b>                      | <b>24</b> |
| .....  | 25        |
| .....  | 26        |
| 2.2.1 Main Memory.....                                     | 26        |
| .....  | 28        |
| .....  | 30        |
| 2.4.1 AT/ATX Power Select (JAT1, JSUS1) .....              | 30        |
| 2.4.2 Clear CMOS (JCMOS1) .....                            | 31        |
| 2.4.3 PCI-104 Voltage Select (JVIO1) .....                 | 31        |
| 2.4.4 Audio connector (JAUD1).....                         | 32        |
| 2.4.5 CD-ROM Audio Input Connector (JCD1) .....            | 33        |
| 2.4.6 Serial Port 1 Connector (JCOM1) .....                | 34        |
| 2.4.7 Serial Port 2 Connector in RS-232 Mode (JCOM2) ..... | 35        |
| 2.4.8 Serial Port 2 Connector in RS-422 Mode (JCOM2) ..... | 35        |
| 2.4.9 Serial Port 2 Connector in RS-485 Mode (JCOM2) ..... | 36        |
| 2.4.10 General Purpose I/O Connector (JDIO1).....          | 38        |
| 2.4.11 System Fan Connector (JFAN1&2) .....                | 38        |
| 2.4.12 Primary IDE Connector (JIDE1).....                  | 39        |
| 2.4.13 LCD Inverter Connector (JINV1).....                 | 41        |
| 2.4.14 IrDA Connector (JIR1) .....                         | 42        |
| 2.4.15 PS/2 Keyboard & Mouse Connector (JKB1).....         | 43        |
| 2.4.16 RJ-45 Ethernet (JLAN1, JLAN2).....                  | 43        |
| 2.4.17 LVDS Connector (JLVDS1) .....                       | 44        |

|           |  |           |
|-----------|--|-----------|
| 2.4.18    | ATX Power Switch Connector (JPS1) .....                    | 45        |
| 2.4.19    | Power Connector (JPWR1).....                               | 45        |
| 2.4.20    | TV Connector (JTV1) .....                                  | 46        |
| 2.4.21    | USB Connector 0 & 1 (JUSB1).....                           | 46        |
| 2.4.22    | USB Connector 2 & 3 (JUSB2).....                           | 48        |
| 2.4.23    | VGA Connector (JVGA1).....                                 | 49        |
| 2.4.24    | LCD Backlight Brightness Adjustment Connector (JVR1) ..... | 50        |
| <b>3.</b> | <b>BIOS Setup .....</b>                                    | <b>51</b> |
|           | .....  | 52        |
|           | .....  | 53        |
|           | .....  | 54        |
|           | .....  | 54        |
|           | .....  | 55        |
| 3.5.1     | Standard CMOS Features.....                                | 56        |
| 3.5.2     | Advanced BIOS Features.....                                | 58        |
| 3.5.3     | Advanced Chipset Features.....                             | 62        |
| 3.5.4     | Integrated Peripherals .....                               | 67        |
| 3.5.5     | Power Management Setup.....                                | 72        |
| 3.5.6     | PnP / PCI Configuration .....                              | 75        |
| 3.5.7     | PC Health Status.....                                      | 77        |
| 3.5.8     | Frequency / Voltage Control .....                          | 78        |
| 3.5.9     | Load Fail-Safe Defaults.....                               | 78        |
| 3.5.10    | Load Optimized Defaults.....                               | 79        |
| 3.5.11    | Set Supervisor / User Password.....                        | 79        |
| 3.5.12    | Save & Exit Setup .....                                    | 81        |
| 3.5.13    | Exit Without Save.....                                     | 81        |
| <b>4.</b> | <b>Drivers Installation .....</b>                          | <b>82</b> |
|           | .....  | 83        |
|           | .....  | 84        |
|           | .....  | 85        |
|           | .....  | 86        |
|           | .....  | 87        |
|           | .....  | 88        |
| <b>5.</b> | <b>Mechanical Drawing .....</b>                            | <b>90</b> |
|           | <b>Appendix A: BIOS Revisions .....</b>                    | <b>92</b> |
|           | <b>Appendix B: AWARD BIOS POST Messages .....</b>          | <b>93</b> |
|           | .....  | 94        |
|           | .....  | 94        |
|           | .....  | 94        |
| 1.        | CMOS BATTERY HAS FAILED .....                              | 94        |

## ECM-CX700

|     |  |    |
|-----|--|----|
| 2.  | CMOS CHECKSUM ERROR .....  | 94 |
| 3.  | DISK BOOT FAILURE, INSERT SYSTEM DISK AND PRESS ENTER .....                      | 94 |
| 4.  | DISKETTE DRIVES OR TYPES MISMATCH ERROR - RUN SETUP .....                        | 94 |
| 5.  | DISPLAY SWITCH IS SET INCORRECTLY .....  | 95 |
| 6.  | DISPLAY TYPE HAS CHANGED SINCE LAST BOOT .....                                   | 95 |
| 7.  | EISA Configuration Checksum Error PLEASE RUN EISA CONFIGURATION UTILITY .....    | 95 |
| 8.  | EISA Configuration Is Not Complete PLEASE RUN EISA CONFIGURATION UTILITY .....   | 95 |
| 9.  | ERROR ENCOUNTERED INITIALIZING HARD DRIVE.....                                   | 95 |
| 10. | ERROR INITIALIZING HARD DISK CONTROLLER .....                                    | 95 |
| 11. | FLOPPY DISK CNTRLR ERROR OR NO CNTRLR PRESENT .....                              | 95 |
| 12. | Invalid EISA Configuration PLEASE RUN EISA CONFIGURATION UTILITY .....           | 96 |
| 13. | KEYBOARD ERROR OR NO KEYBOARD PRESENT .....                                      | 96 |
| 14. | Memory Address Error at .....  | 96 |
| 15. | Memory parity Error at .....   | 96 |
| 16. | MEMORY SIZE HAS CHANGED SINCE LAST BOOT .....                                    | 96 |
| 17. | Memory Verify Error at ... .....   | 96 |
| 18. | OFFENDING ADDRESS NOT FOUND .....  | 96 |
| 19. | OFFENDING SEGMENT: .....   | 96 |
| 20. | PRESS A KEY TO REBOOT .....  | 97 |
| 21. | PRESS F1 TO DISABLE NMI, F2 TO REBOOT.....                                       | 97 |
| 22. | RAM PARITY ERROR - CHECKING FOR SEGMENT ... .....                                | 97 |
| 23. | Should Be Empty But EISA Board Found PLEASE RUN EISA CONFIGURATION UTILITY ..... | 97 |
| 24. | Should Have EISA Board But Not Found PLEASE RUN EISA CONFIGURATION UTILITY ..... | 97 |
| 25. | Slot Not Empty .....   | 97 |
| 26. | SYSTEM HALTED, (CTRL-ALT-DEL) TO REBOOT ... .....                                | 97 |
| 27. | Wrong Board In Slot PLEASE RUN EISA CONFIGURATION UTILITY .....                  | 98 |
| 28. | FLOPPY DISK(S) fail (80) → Unable to reset floppy subsystem.....                 | 98 |
| 29. | FLOPPY DISK(S) fail (40) → Floppy Type mismatch.....                             | 98 |
| 30. | Hard Disk(s) fail (80) → HDD reset failed.....                                   | 98 |
| 31. | Hard Disk(s) fail (40) → HDD controller diagnostics failed.....                  | 98 |
| 32. | Hard Disk(s) fail (20) → HDD initialization error.....                           | 98 |
| 33. | Hard Disk(s) fail (10) → Unable to recalibrate fixed disk.....                   | 98 |
| 34. | Hard Disk(s) fail (08) → Sector Verify failed.....                               | 98 |
| 35. | Keyboard is locked out - Unlock the key. ....                                    | 98 |
| 36. | Keyboard error or no keyboard present. ....                                      | 98 |
| 37. | Manufacturing POST loop.....   | 98 |
| 38. | BIOS ROM checksum error - System halted. ....                                    | 98 |
| 39. | Memory test fail. ....   | 98 |
| 40. | POST Codes .....   | 99 |



# 1. Getting Started

## 1.1 Safety Precautions

### Warning!



Always completely disconnect the power cord from your chassis whenever you work with the hardware. Do not make connections while the power is on. Sensitive electronic components can be damaged by sudden power surges. Only experienced electronics personnel should open the PC chassis.

**Always note** that improper disassembling action could cause damage to the motherboard.

We suggest not removing the heatsink without correct instructions in any circumstance.

If you really have to do this, please contact us for further support.

### Caution!



Always ground yourself to remove any static charge before touching the CPU card. Modern electronic devices are very sensitive to static electric charges. As a safety precaution, use a grounding wrist strap at all times. Place all electronic components in a static-dissipative surface or static-shielded bag when they are not in the chassis.

## 1.2 Packing List

Before you begin installing your single board, please make sure that the following materials have been shipped:

- 1 x ECM-CX700 VIA Eden V4 Micro module
- 1 x Quick Installation Guide for ECM-CX700
- 1 x DVD-ROM or CD-ROM contains the followings:
  - User's Manual (this manual in PDF file)
  - Ethernet/VGA/Audio drivers and utilities
- 1 x Cable set contains the followings:
  - 1 x Daughter board support Audio/2 x USB (P/N:E9697000105R)
  - 1 x IDE HDD cable (40-pin, pitch 2.54mm)
  - 1 x USB cable (10-pin/2.54mm-10pin/2.0mm)
  - 1 x Audio cable (12-pin, pitch 2.0mm)
  - 1 x Serial ATA cable (7-pin, standard)
  - 1 x Serial port cable (10-pin, pitch 2.0mm)
  - 1 x PS/2 Keyboard & Mouse Y cable (6-pin, Mini-DIN)



If any of the above items is damaged or missing, contact your retailer.

### 1.3 Document Amendment History

| Revision | Date      | By         | Comment  |
|----------|-----------|------------|--|
| 1st      | Nov. 2006 | Lingo Tsai | Initial Release  |
|          | Mar. 2007 | Lingo Tsai | Logo changed   |
| 2nd      | Jun. 2007 | Lingo Tsai | <ol style="list-style-type: none"> <li>1. Cable list update</li> <li>2. JCMOS1's pin definition modified</li> <li>3. JIDE1's pin definition modified</li> <li>4. JLVDS1's pin definition modified</li> <li>5. JTV1's pin definition modified</li> <li>6. Audio driver installation modified</li> </ol> |
| 3rd      | Feb. 2008 | Lingo Tsai | <ol style="list-style-type: none"> <li>1. P.13, 14 specification modified (weight, size,..)</li> <li>2. Address/Phone/Email modified for China/USA branch</li> <li>2. P.25 product overview modified(JFAN2)</li> <li>3. Mechanical drawing modified on P.91</li> </ol>                                 |

## 1.4 Manual Objectives

This manual describes in detail the Avalue Technology ECM-CX700 Single Board.



We have tried to include as much information as possible but we have not duplicated information that is provided in the standard IBM Technical References, unless it proved to be necessary to aid in the understanding of this board.



We strongly recommend that you study this manual carefully before attempting to interface with ECM-CX700 series or change the standard configurations. Whilst all the necessary information is available in this manual we would recommend that unless you are confident, you contact your supplier for guidance.

Please be aware that it is possible to create configurations within the CMOS RAM that make booting impossible. If this should happen, clear the CMOS settings, (see the description of the Jumper Settings for details).

If you have any suggestions or find any errors concerning this manual and want to inform us of these, please contact our Customer Service department with the relevant details.

## 1.5 System Specifications

| <b>System</b>     |  |
|--|--|
| <b>CPU</b>   | Onboard VIA Eden V4 1 GHz  |
| <b>BIOS</b>  | Award 512 KB Flash BIOS  |
| <b>System Chipset</b>  | VIA CX700M   |
| <b>I/O Chip</b>  | VIA VT1211   |
| <b>System Memory</b>   | One 200-pin DDR2 SODIMM socket supports up to 1 GB DDR2 400/533 SDRAM  |
| <b>SSD</b>   | One CompactFlash Type I/II socket  |
| <b>Watchdog Timer</b>  | Reset: 1~255 sec. and 1 sec. or 1 min./step  |
| <b>H/W Status Monitor</b>  |  |
| <b>Expansion</b>   | One PCI-104 connector  |
| <b>I/O</b>        |  |
| <b>MIO</b>   | 1 x EIDE (Ultra DMA 133), 2 x SATA, 1 x RS-232, 1 x RS-232/422/485, 1 x K/B & Mouse  |
| <b>IrDA</b>  | 115k bps, IrDA 1.0 compliant   |
| <b>USB</b>   | 4 x USB 2.0 ports  |
| <b>Display</b>  |  |
| <b>Chipset</b>   | VIA CX700M with integrated 2D and 3D Graphics engine supporting MPEG-4 accelerator, MPEG-2 decoder and WMV9 Video acceleration |
| <b>Display Memory</b>  | 32 / 64 / 128 MB frame buffer using system memory  |
| <b>Resolution</b>  | CRT mode: 1920 x 1440 @ 24 bpp (75 Hz)<br>LCD/Simultaneous mode: 1600 x 1200 @ 24 bpp (60 Hz)                                  |
| <b>LVDS</b>  | Dual-channel 18/24-bit LVDS  |
| <b>DVI</b>   | VIA CX700M DVI interface   |
| <b>TV-out</b>  | VIA CX700M HDTV encoder supports both NTSC/PAL<br>Supports both S-video, composite video, and component YPb(Cb)Pr(Cr)          |

| <b>Audio</b>                           |   |
|---|---|
| Chipset   | VIA CX700M  |
| AC97 Codec  | Realtek ALC883 supports 5.1 CH Audio and 7.1 CH with SPDIF                |
| Audio Interface   | Mic in, Line in, CD Audio in, Line out                                    |
| <b>Ethernet</b>                        |   |
| Chipset   | Dual Realtek RTL8101L   |
| Ethernet Interface  | 100Base-Tx Fast Ethernet compatible: Realtek RTL8101L                     |
| <b>Mechanical &amp; Environmental</b>  |   |
| Power Requirement   | +5 V @ 3.5 A, +5VSB @ 0.13 A (with VIA Eden 1.5GHz & 1 GB DDR2 533 SDRAM) |
| Power Type  | AT/ATX  |
| Operation Temperature   | 0~60@ C (32~140@ F)   |
| Operating Humidity  | 0%~90% relative humidity, non-condensing                                  |
| Size ( L x W )  | 5.7" x 4" (146 mm x 101 mm)   |
| Weight  | 0.44 lbs (0.23 kg)  |

## 1.6 Architecture Overview

### 1.6.1 Block Diagram

The following block diagram shows the architecture and main components of ECM-CX700 Series.

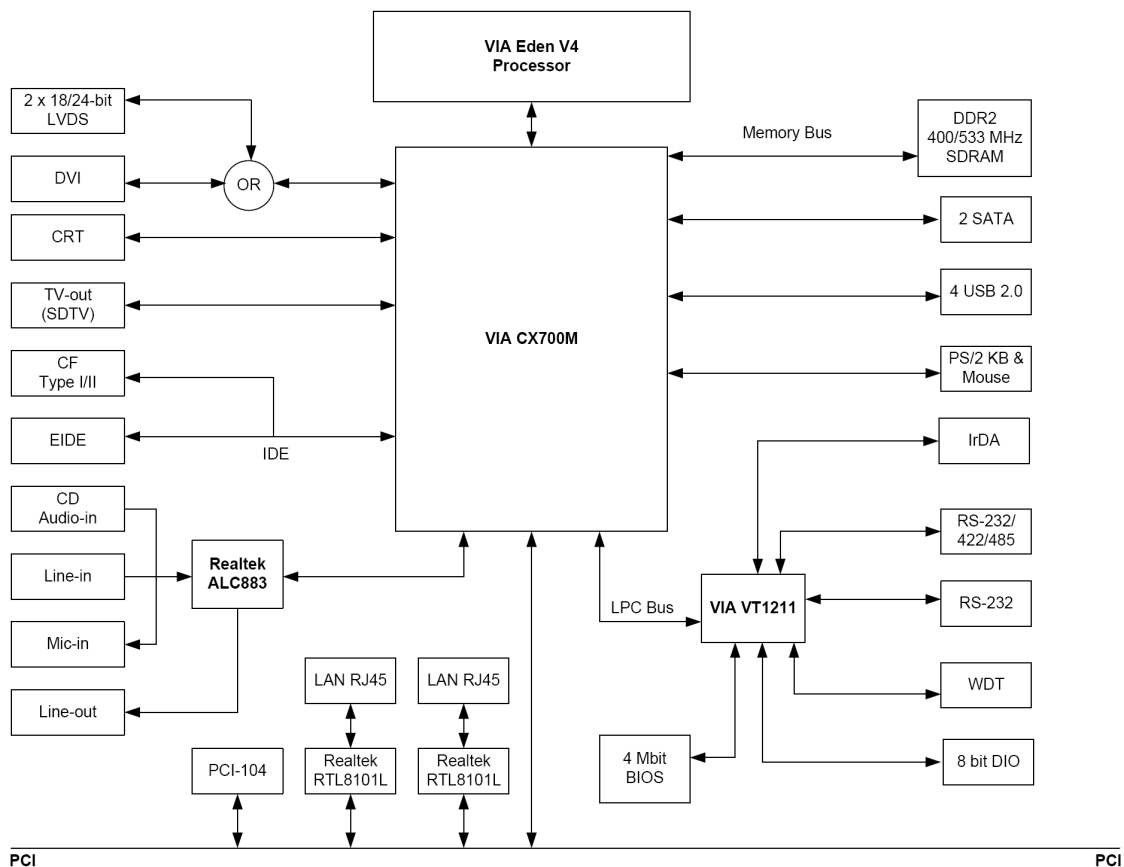

The following sections provide detail information about the functions provided onboard.

## 1.6.2 VIA CX700M



The VIA CX700M integrates premium graphics, audio, memory, storage, and HDTV support all in a single chip design. This unified design enables the creation of smaller form factor designs, reduced power consumption, and easier cooling, all of which opens the door for an expanded range of embedded solutions. This is all done in a single chip package exactly the same size as a North bridge, i.e. 37.5mm x 37.5mm, representing a saving of over 34% in board real estate. This represents a major breakthrough for the embedded industry where ultra compactness is essential, and will have significant benefit for embedded boards such as PC/104 and VIA EPIA mainboards.

Complementing the power-efficient VIA C7 and fanless VIA Eden processors it supports, the VIA CX700M is based on a highly sophisticated power efficient architecture that enables such rich integration into a compact package with a maximum power envelope of just 3.5 watts. A number of key power management technologies are incorporated that monitor activity and dynamically control power according to system load requirements.

Targeted for key embedded applications such as Point of Sales (POS) equipment, industrial PCs (IPC) and ultra compact, low power desktop systems such as thin clients, the VIA CX700M has been designed from the ground up to deliver excellent performance, features and power efficiency. The reduction in board space and operating power requirements together with the extensive multimedia, memory, connectivity and display flexibility provides embedded customers with the ideal chipset to take their ultra compact systems to the next stage.

The VIA CX700M utilizes the VIA UniChrome™ Pro Integrated Graphics Processor (IGP) ensuring optimal performance for all multimedia, entertainment, and productivity applications. With an internal data flow equivalent to the latest AGP 8X graphics cards, a 200MHz 2D/3D graphics engine and features dedicated 128-bit data paths for pixel data flow and texture/command access.

The VIA UniChrome Pro IGP graphics core also features the Chromotion™ video engine raising the bar for digital entertainment support on PC systems. The Chromotion™ video engine employs a multi-faceted approach to displaying multimedia content, implementing a number of advanced tools at every stage of video processing. These include integrated MPEG-2 decoding, for flawless digital video playback with ultra-low CPU-utilization, and advanced rendering tools such as Adaptive De-Interlacing and Video Deblocking, which ensure clearer playback of digital content on all display devices.

## ECM-CX700

The benefit of VIA CX700M can be introduced as below:

- Advanced HDTV Display Support

Flexibility is extended to display technologies, with the VIA CX700M integrating a built in HDTV encoder for connection to the latest displays, and multi-configuration LVDS/DVI transmitter.

- VIA UniChrome™ Pro Graphics Core

With an internal data flow equivalent to what is available to the latest AGP 8X graphics cards, VIA UniChrome Pro has a separate 128-bit data path between the North Bridge for pixel data flow and texture/command access. Separate 128-bit 2D and 3D graphics engines ensure optimal performance for all multimedia, entertainment, and productivity applications.

- Chromotion Video Engine

VIA UniChrome Pro includes native support for the most popular digital video and audio formats through hardware MPEG-2 playback and acclaimed VIA Vinyl HD Audio suite, supporting up to eight high definition channels delivering a richer all-around digital media experience. The image enhancement technology delivering a Hi-Def™ visual experience including advanced video acceleration for MPEG-2, MPEG-4, and WMV9.

- Advanced Memory Controller

VIA's renowned memory controller technology has been incorporated into the VIA CX700M, with support for both DDR400 and the high-bandwidth DDR2 533 memory up to 4GB with ECC capability, and 32-bit as well as 64-bit system memory to extend performance, design and cost flexibility to developers.

- VIA Advanced Connectivity

The VIA CX700M offers broad connectivity with support for SATA, SATA II and PATA drives, two COM and six USB2.0 ports, and four PCI slots, allowing for considerable flexibility in board configuration. Additionally, developers can also integrate support for ISA through an ITE PCI bridge chip, combining legacy ISA connectivity with high bandwidth DDR2 memory support for more powerful embedded systems.

- Unified VIA Hyperion Pro Drivers

VIA's unified approach to drivers has been established for eight generations of chipsets, allowing end users to benefit from seamless hardware and software compatibility.

Here are the brief key features for VIA CX700M:

- 533MB/sec Front Side Bus
- Supports up to 4GB DDR2 533/400MHz or DDR400/333/266MHz SDRAM

Integrated VIA UniChrome Pro Graphics

- Integrated VIA UniChrome Pro Graphics
- Built in HDTV Encoder
- Chromotion™ video engine



- MPEG-2 Decoder
- Video De-blocking
- Adaptive De-Interlace
- DuoView+™
- Optimized Unified memory Architecture (UMA)
- 200MHz Graphics Engine Clock with separated 128-bit data paths
- 128-bit 2D and 3D Graphics engine
- Multi-configuration LVDS/DVI transmitter
- Support for VIA Vinyl HD Audio
- Serial ATA support for up to 2 devices
- Parallel ATA133/100/66 support for up to 2 devices
- Support for up to 6 USB 2.0 ports

## ECM-CX700

### 1.6.3 Realtek ALC883 AC'97 Codec

The ALC883 series 7.1+2 Channel High Definition Audio (HDA) codecs are compliant with Microsoft's UAA (Universal Audio Architecture). The ALC883 series provide 10 DAC channels that simultaneously support 7.1 sound playback, plus 2 channels of independent stereo sound output (multiple streaming) through the front panel stereo output. Flexible mixing, mute, and fine gain control functions provide a complete integrated audio solution for home entertainment PCs.

The ALC883 series also integrate two stereo ADCs that can support a stereo microphone with Acoustic Echo Cancellation (AEC), Beam Forming (BF), and Noise Suppression (NS) technology simultaneously.

All analog IO are input and output capable, and headphone amplifiers are also integrated at each analog output. All analog IOs can be re-tasked according to user's definitions, or automatically switched depending on the connected device type.

The ALC883 series support 16/20/24 S/PDIF input and output to offer easy connection of PCs to high quality consumer electronic products such as digital decoders and speakers.

The ALC883 series support host/soft audio from the Intel ICH series chipset, and also from any other HDA compatible audio controller. With EAX/Direct Sound 3D/I3DL2/A3D compatibility, and excellent software utilities like Karaoke mode, environment emulation, software equalizer, HRTF 3D positional audio, and optional Dolby® Digital Live and DTS® Connect program, the ALC883 series provide an excellent entertainment package and game experience for PC users.

#### Features

- High-performance DACs with 95dB SNR (A-Weighting), ADCs with 85dB SNR (A-Weighting)
- Meets performance requirements for audio on PC2001 systems and Microsoft WLP 2.x
- Ten DAC channels support 16/20/24-bit PCM format for 7.1 sound playback, plus 2 channels of independent stereo sound output (multiple streaming) through the front panel output
- 2 stereo ADCs support 16/20/24-bit PCM format, one for stereo microphone, the other for legacy mixer recording

- All DACs support 44.1k/48k/96k/192kHz sample rate
- All ADCs support 44.1k/48k/96kHz sample rate
- 16/20/24-bit S/PDIF-OUT supports 44.1k/48k/96k/192kHz sample rate
- 16/20/24-bit S/PDIF-IN supports 44.1k/48k/96kHz sample rate
- Up to four channels of microphone array input are supported for AEC/BF application
- High-quality analog differential CD input
- Supports external PCBEEP input and built-in digital BEEP generator
- Software selectable 2.5V/3.75V VREFOUT
- Two jack detection pins, each designed to detect up to 4 jacks
- Reserve analog mixer architecture for backward compatibility with AC'97
- Wide range (-80dB ~ +42dB) volume control with 1.5dB resolution of analog to analog mixer gain
- All analog jacks are stereo input and output re-tasking for analog plug & play
- Built-in headphone amplifiers for each re-tasking jack
- 2 GPIOs (General Purpose Input/Output) for customized applications
- Power support: Digital: 3.3V; Analog: 3.0V~5.0V (Minimum AVDD is 3.0V)
- Pin compatible with the ALC880 and ALC882
- Enhanced S/PDIF-IN circuitry ensures compatibility with consumer DVD players
- 48-pin LQFP 'Green' package
- Meets Microsoft WHQL/WLP 2.x audio requirements
- EAX™ 1.0 & 2.0 compatible
- Direct Sound 3D™ compatible
- A3D™ compatible
- I3DL2 compatible
- HRTF 3D Positional Audio
- Emulation of 26 sound environments to enhance gaming experience
- 10-Band Software Equalizer
- Voice Cancellation and Key Shifting in Karaoke mode
- Realtek Media Player
- Enhanced Configuration Panel to improve user experience
- Microphone Acoustic Echo Cancellation (AEC), Noise Suppression (NS), and Beam Forming (BF) technology for voice application
- ALC883D features optional Dolby® Digital Live output for consumer equipment
- ALC883DTS features optional DTS® Connect software

## ECM-CX700

### 1.6.4 VIA VT1211 Super I/O

The VT1211 is a full function Super I/O chip with a Floppy Disk Controller, an IEEE-1284 Parallel Port interface, two 16C550-UART-based serial port interfaces, a VFIR (Very Fast IR) Controller, a game port which supports 2 joysticks, a MIDI interface, and a 4M Flash-ROM interface.

The integrated Hardware Monitor Controller controls the speed of 2 fans, monitors 2 fan tachometers, and has a Pentium II thermal diode and 5 universal analog inputs for measuring voltage or temperature (by connecting external thermistors).

The VT1211 meets the "Microsoft PC98 and PC99 system design guide" requirements and is ACPI ready, and a hardware monitor engine is built in to monitor system health.

#### Key Features

- LPC (Low Pin Count) Interface
  - Complies with Intel Low Pin Count Interface Specification Revision 1.0
  - Supports LDRQ#, SERIRQ protocols
- Hardware Monitor Controller
  - Built-in 8-bit Analog to Digital Converter
  - One thermal input for Pentium II type thermal diode
  - 1 intrinsic Vcc voltage monitor input
  - 5 external Universal Channels for monitor inputs
  - Monitors 2 fan tachometer inputs
  - 1 chassis open detection input
  - WatchDog comparison of all monitored values
  - Provides VID0 - VID4 support for P6 class CPU
  - Over temperature indicator output
  - Over limit of fan and voltage indicator output
  - Provides beep tone warning
  - Serial Bus slave mode supported
- Fan Speed Controller
  - Provides fan on-off and speed control
  - Supports 2 programmable Pulse Width Modulation (PWM) outputs
  - Duty cycle resolution of 1/256
- Flash-ROM Interface
  - Supports up to 4MB flash ROM
- SmartGuardian Controller
  - Provides automatic temperature to fan speed control
  - Supports mix-and-match for temperature inputs and fan speed control outputs

- Overrides fan speed controller during catastrophic situations
- Provides over-temperature beep tone warning
- Two 16C550 UARTs
  - Supports two standard Serial Ports
  - Each port supports Serial Port
- IEEE1284 Parallel Port
  - Standard mode -- Bi-directional SPP
  - Enhanced mode -- EPP V1.7 and 1.9 compliant
  - High speed mode -- ECP, IEEE1284 compliant
  - Backdrive current reduction
  - Printer power-on damage reduction
- Floppy Disk Controller
  - Supports two 360K / 720K / 1.2M / 1.44M / 2.88M floppy disk drives
  - Enhanced digital data separator
  - 3-Mode drives supported
- Game Port
  - Built-in 558 quad timers and buffer chips
  - Supports direct connection to two joysticks
- Dedicated MIDI Interface
  - UART implementation
  - Supports direct connect to MPU-401 MIDI
- 56 General Purpose I/O Pins
  - Input mode supports switch de-bounce
  - Output mode supports one set of programmable LED blinking periods
- Watch Dog Timer
  - Times out the system, based on a user-programmable time-out period
  - Time resolution 1 minute, maximum 255 minutes
- Dedicated Infrared pins
  - Compliant with IrDA 1.4 for VFIR
- Single 48MHz Clock Input
- Single 3.3V Power Supply
- 128-pin LPQF

## ECM-CX700

### 1.6.5 Ethernet-Realtek RTL8101L Ethernet Controller

The Ethernet interface is based on an Realtek RTL8101L Ethernet controller which supports both 100Mbit as well as 10Mbit Base-T interface.

The Ethernet controller is attached to the PCI bus and use PCI bus mastering for data transfer. The CPU is thereby not loaded during the actual data transfer.

The Realtek RTL8101L is a highly integrated and cost-effective single-chip Fast Ethernet controller that provides 32-bit performance, PCI bus master capability, and full compliance with IEEE 802.3u 100Base-TX specifications and IEEE 802.3x Full Duplex Flow Control. It also supports the Advanced Configuration Power management Interface (ACPI), PCI power management for modern operating systems that are capable of Operating System Directed Power Management (OSPM) to achieve the most efficient power management possible. The RTL8101L no longer supports CardBus mode as RTL8139C does. In addition to the ACPI feature, the RTL8101L also supports remote wake-up (including AMD Magic Packet, LinkChg, and Microsoft® wake-up frame) in both ACPI and APM environments. The RTL8101L is capable of performing an internal reset through the application of auxiliary power.

To provide cost down support, the RTL8101L is capable of using a 25MHz crystal or OSC as its internal clock source. The RTL8101L keeps network maintenance costs low and eliminates usage barriers. It is the easiest way to upgrade a network from 10 to 100Mbps. It also supports full-duplex operation, making 200Mbps bandwidth possible at no additional cost. To improve compatibility with other brands' products, the RTL8101L is also capable of receiving packets with InterFrameGap no less than 40 Bit-Time. The RTL8101L is highly integrated and requires no "glue" logic or external memory.

The RTL8101L includes a PCI and Expansion Memory Share Interface (Realtek patent) for a boot ROM and can be used in diskless workstations, providing maximum network security and ease of management.

### **1.6.6 Compact Flash Interface**

A Compact Flash type II connector is connected to the secondary IDE controller. The Compact Flash storage card is IDE compatible. It is an ideal replacement for standard IDE hard drives. The solid-state design offers no seek errors even under extreme shock and vibration conditions. The Compact Flash storage card is extremely small and highly suitable for rugged environments, thus providing an excellent solution for mobile applications with space limitations. It is fully compatible with all consumer applications designed for data storage PC card, PDA, and Smart Cellular Phones, allowing simple use for the end user. The Compact Flash storage card is O/S independent, thus offering an optimal solution for embedded systems operating in non-standard computing environments. The Compact Flash storage card is IDE compatible and offers various capacities.

# 2. Hardware Configuration

---



## 2.1 Product Overview

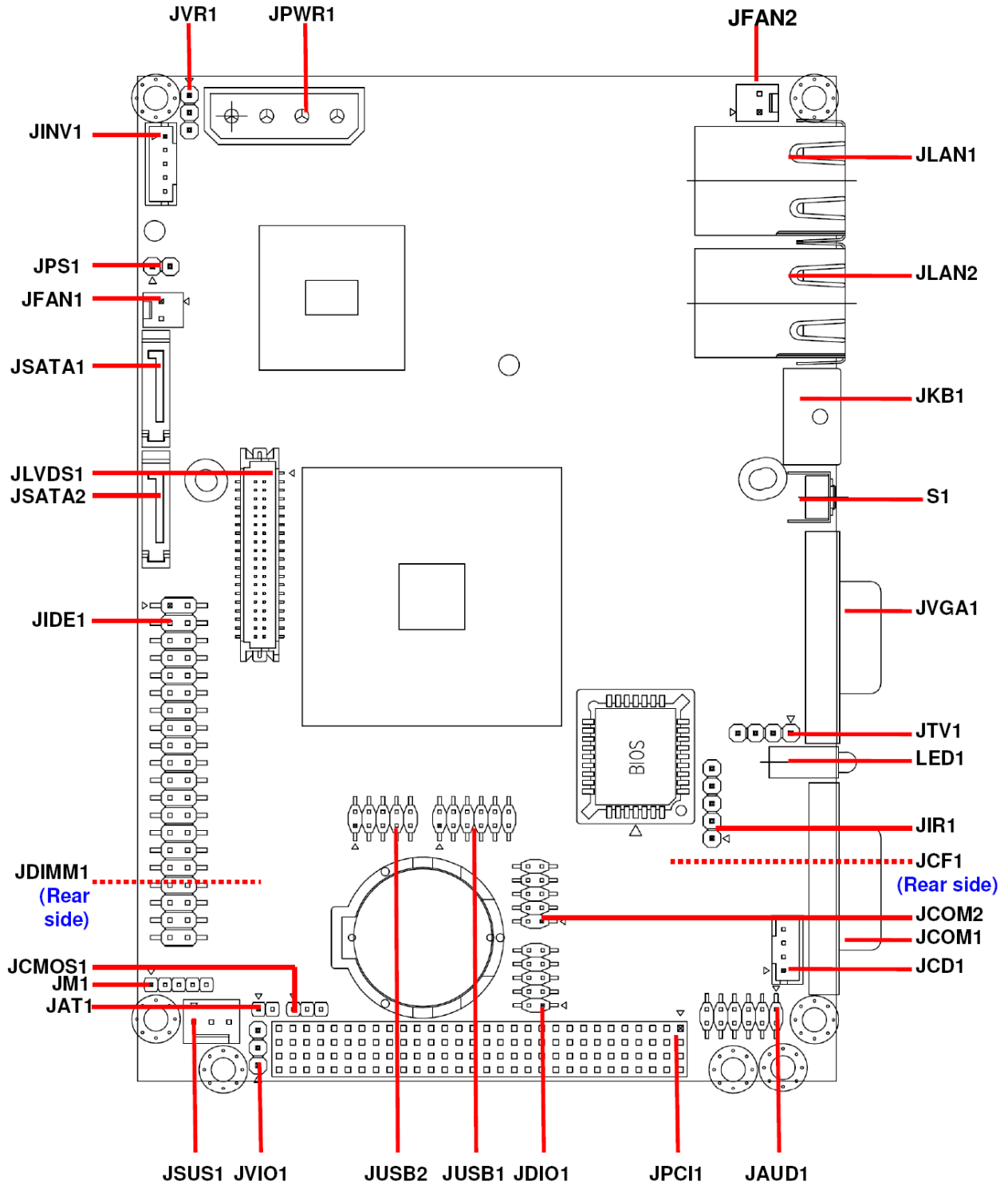

## 2.2 Installation Procedure

This chapter explains you the instructions of how to setup your system.

1. Turn off the power supply.
2. Insert the SODIMM module (be careful with the orientation).
3. Insert all external cables for hard disk, floppy, keyboard, mouse, USB etc. except for flat panel. A CRT monitor must be connected in order to change CMOS settings to support flat panel.
4. Connect power supply to the board via the JPWR.
5. Turn on the power.
6. Enter the BIOS setup by pressing the delete key during boot up. Use the “LOAD BIOS DEFAULTS” feature. The **Integrated Peripheral Setup** and the **Standard CMOS Setup** Window must be entered and configured correctly to match the particular system configuration.
7. If TFT panel display is to be utilized, make sure the panel voltage is correctly set before connecting the display cable and turning on the power.

### 2.2.1 Main Memory

ECM-CX700 series provides one 200-pin SODIMM sockets to support DDR2 SDRAM. The maximum memory size is 1GB.

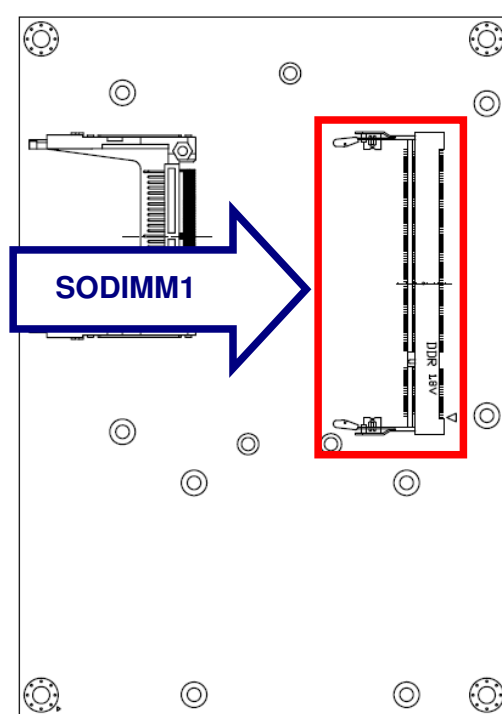

(Rear Side)



Make sure to unplug the power supply before adding or removing SODIMM or other system components. Failure to do so may cause severe damage to both the board and the components.

- Locate the SODIMM socket on the board.
- Hold two edges of the SODIMM module carefully. Keep away of touching its connectors.
- Align the notch key on the module with the rib on the slot.
- Firmly press the modules into the socket automatically snaps into the mounting notch. Do not force the SODIMM module in with extra force as the SODIMM module only fit in one direction.

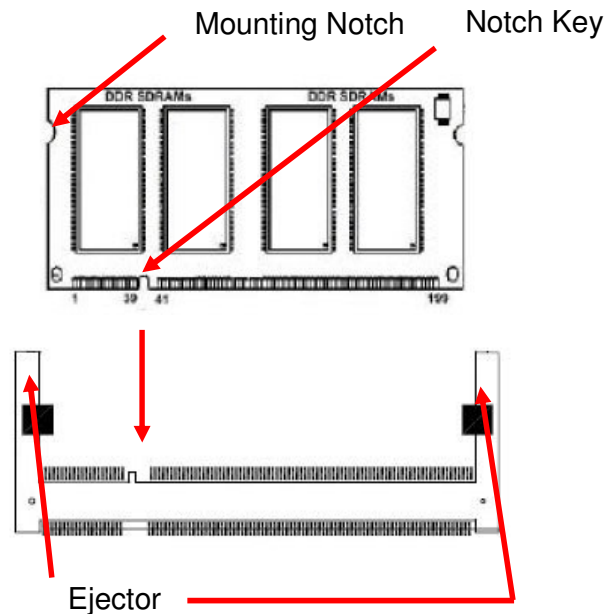

### 200-pin DDR2 SODIMM

- To remove the SODIMM modules, push the two ejector tabs on the slot outward simultaneously, and then pull out the SODIMM module.



- Note:** (1) Please do not change any DDR2 SDRAM parameter in BIOS setup to increase your system's performance without acquiring technical information in advance.
- (2) Static electricity can damage the electronic components of the computer or optional boards. Before starting these procedures, ensure that you are discharged of static electricity by touching a grounded metal object briefly.

## 2.3 Jumper and Connector List

You can configure your board to match the needs of your application by setting jumpers. A jumper is the simplest kind of electric switch.

It consists of two metal pins and a small metal clip (often protected by a plastic cover) that slides over the pins to connect them. To “close” a jumper you connect the pins with the clip. To “open” a jumper you remove the clip. Sometimes a jumper will have three pins, labeled 1, 2, and 3. In this case, you would connect either two pins.

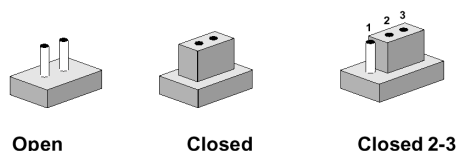

The jumper settings are schematically depicted in this manual as follows:



A pair of needle-nose pliers may be helpful when working with jumpers.

Connectors on the board are linked to external devices such as hard disk drives, a keyboard, or floppy drives. In addition, the board has a number of jumpers that allow you to configure your system to suit your application.

If you have any doubts about the best hardware configuration for your application, contact your local distributor or sales representative before you make any changes.

The following tables list the function of each of the board's jumpers and connectors.

### Jumpers

| Label  | Function               | Note                       |
|--------|------------------------|----------------------------|
| JAT1   | AT/ATX power select    | 2 x 1 header, pitch 2.00mm |
| JSUS1  |                        | 3 x 1 header, pitch 2.54mm |
| JCMOS1 | Clear CMOS             | 3 x 1 header, pitch 2.00mm |
| JVIO1  | PCI 104 voltage select | 3 x 2 header, pitch 2.54mm |

## Connectors

| Label              | Function   | Note                        |
|--------------------|--|-----------------------------|
| <b>JAUD1</b>       | Audio connector  | 6 x 2 header, pitch 2.0mm   |
| <b>JCD1</b>        | CD-ROM audio input connector                           | 4 x 1 wafer, pitch 2.0mm    |
| <b>JCF1</b>        | Compact Flash card connector                           |                             |
| <b>JCOM1</b>       | Serial port 1 connector                                | 5 x 2 header, pitch 2.0mm   |
| <b>JCOM2</b>       | Serial port 2 connector                                | 5 x 2 header, pitch 2.0mm   |
| <b>JSODIMM1</b>    | DDR2 SODIMM 1.8V                                       | 200-pin DDR2 SODIMM socket  |
| <b>JDIO1</b>       | General purpose I/O connector                          | 5 x 2 header, pitch 2.0mm   |
| <b>JFAN1&amp;2</b> | CPU fan connector                                      | 2 x 1 wafer, pitch 2.54mm   |
| <b>JIDE1</b>       | Primary IDE connector                                  | 20 x 2 header, pitch 2.54mm |
| <b>JINV1</b>       | LCD inverter connector                                 | 5 x 1 wafer, pitch 2.0mm    |
| <b>JIR1</b>        | IrDA connector   | 5 x 1 header, pitch 2.54mm  |
| <b>JKB1</b>        | PS/2 keyboard & mouse connector                        | 6-pin mini DIN              |
| <b>JLAN1</b>       | RJ-45 Ethernet 1                                       |                             |
| <b>JLAN2</b>       | RJ-45 Ethernet 2                                       |                             |
| <b>JLVDS1</b>      | LVDS connector   | HIROSE DF13-40DP-1.25V      |
| <b>JM1</b>         | Lord Port <a href="#">(for Firmware updating only)</a> | 5 x 1 header, pitch 2.0mm   |
| <b>JPCI1</b>       | PCI-104 connector                                      | 5 x 2 header, pitch 2.0mm   |
| <b>JPS1</b>        | ATX power switch connector                             | 2 x 1 header, pitch 2.54mm  |
| <b>JPWR1</b>       | Power connector  | Wafer box 4P 5.08mm         |
| <b>JSATA1</b>      | Serial ATA connector 1<br>Floppy connector             | Wafer 7P pitch 1.27mm       |
| <b>JSATA2</b>      | Serial ATA connector 2                                 | Wafer 7P pitch 1.27mm       |
| <b>JTV1</b>        | Video signal OUT                                       | 4 x 1 header, pitch 2.54mm  |
| <b>JUSB1</b>       | USB connector 0 & 1                                    | 5 x 2 header, pitch 2.0mm   |
| <b>JUSB2</b>       | USB connector 2 & 3                                    | 5 x 2 header, pitch 2.0mm   |
| <b>JVGA1</b>       | VGA connector  | D-sub 15-pin, Female        |
| <b>JVR1</b>        | LCD backlight brightness adjustment                    | 3 x 1 header, pitch 2.54mm  |
| <b>LED1</b>        | Power & HDD indicator                                  |                             |
| <b>S1</b>          | Reset button   |                             |

## 2.4 Setting Jumpers & Connectors

### 2.4.1 AT/ATX Power Select (JAT1, JSUS1)

JAT1

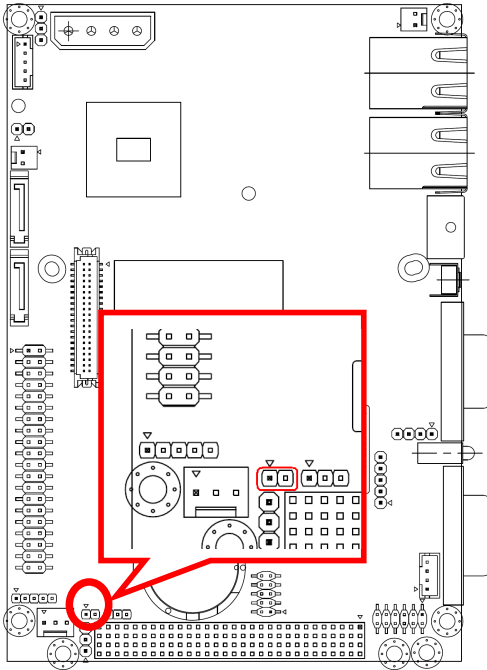

AT\*

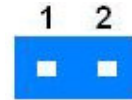

ATX

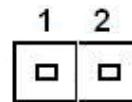

\* Default

JSUS1

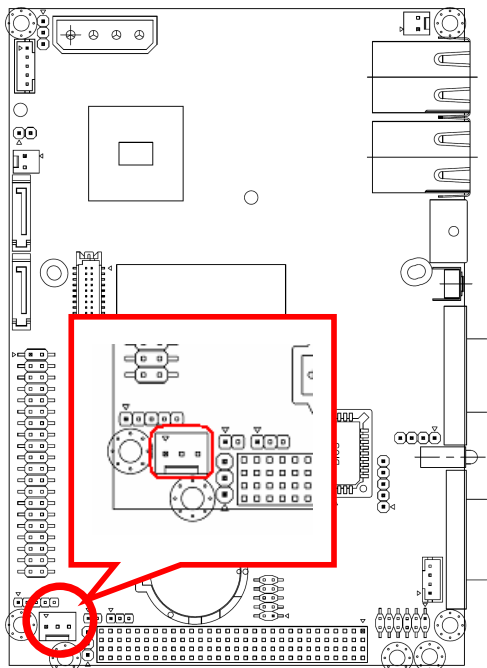

| Signal | PIN |
|--------|-----|
| PWR_ON | 1   |
| +5V    | 2   |
| VCCSB  | 3   |



**Note:** The default sets 2-3 closed for AT power used.

### 2.4.2 Clear CMOS (JCMOS1)

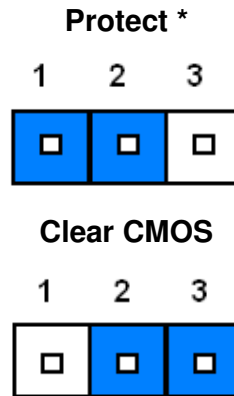
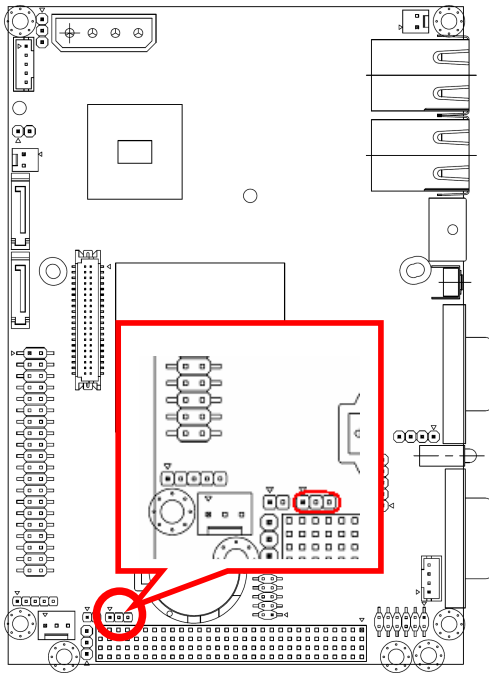

\* Default

### 2.4.3 PCI-104 Voltage Select (JVIO1)

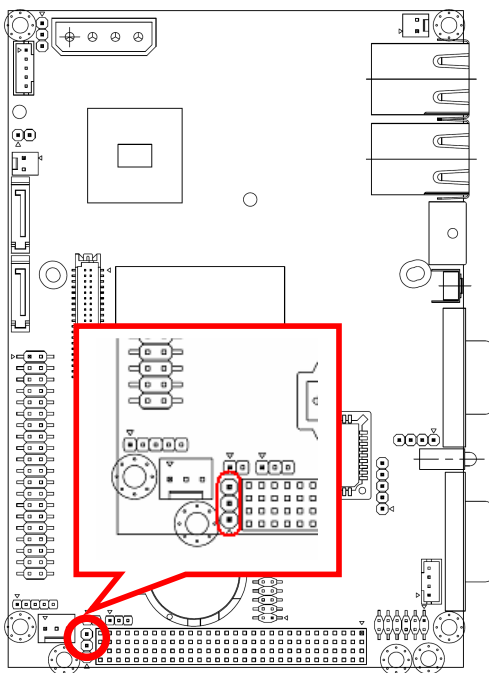

**+5V\***

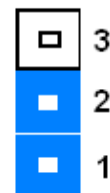

**+3.3V**

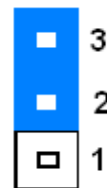

\* Default

# ECM-CX700

## 2.4.4 Audio connector (JAUD1)

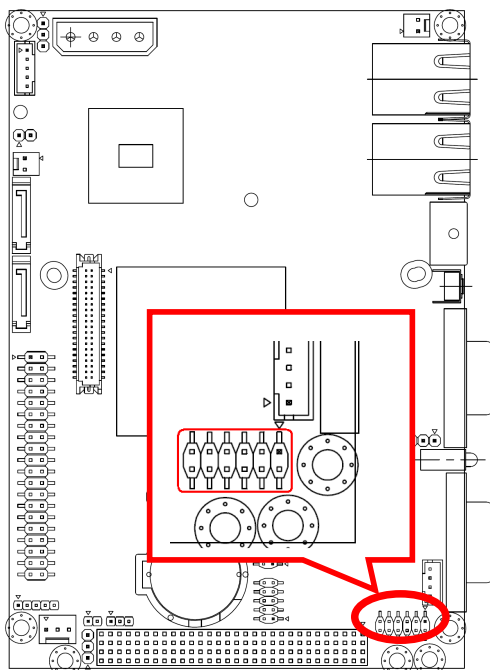

| Signal     | PIN | PIN | Signal     |
|------------|-----|-----|------------|
| LINEOUT_L  | 1   | 2   | LINEOUT_R  |
| GND        | 3   | 4   | LFE-OUT    |
| LIN_L      | 5   | 6   | LIN_R      |
| Mic-in     | 7   | 8   | CEN-OUT    |
| SURR-OUT-L | 9   | 10  | SURR-OUT-R |
| SPDIF OUT  | 11  | 12  | GND        |

\* Default

### 2.4.4.1 Signal Description – Audio Connector (JAUD1)

| Signal       | Signal Description   |
|--------------|--|
| LINEOUT L/R  | Left and right speaker output. These are the speaker outputs directly from the speaker amplifier.  |
| LFE-OUT      | Low Frequency Effect Out channel (un-amplified)  |
| Line-In L/R  | Left and right line in signals.  |
| LN L/R       | Left and right line out signals. Both signals are capacitor coupled and should have GND as return. |
| Mic-in       | The MIC signal is used for microphone input. This input is fed to the left microphone channel.     |
| CEN-OUT      | Center Out channel (im-amplified)  |
| SURR-OUT L/R | Surround Out Felt and Right channel  |
| SPDIF OUT    | PCM Non-Audio Sony/Philips Digital I/F Output (Internal pulled high).                              |



### 2.4.5 CD-ROM Audio Input Connector (JCD1)

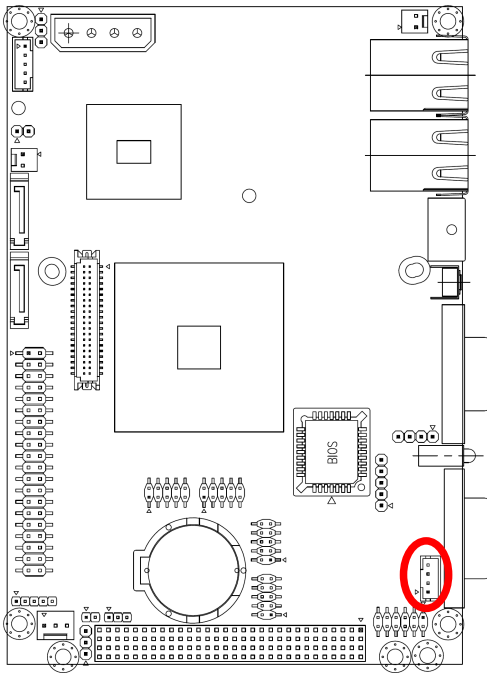

| Signal | PIN |
|--------|-----|
| CD_L   | 4   |
| GND    | 3   |
| CD_R   | 2   |
| GND    | 1   |

#### 2.4.5.1 Signal Description – CD-ROM Audio Input Connector (JCD1)

| Signal | Signal Description |
|--------|--------------------|
| CD_R   | Right CD-IN signal |
| CD_L   | Left CD-IN signal. |

# ECM-CX700

## 2.4.6 Serial Port 1 Connector (JCOM1)

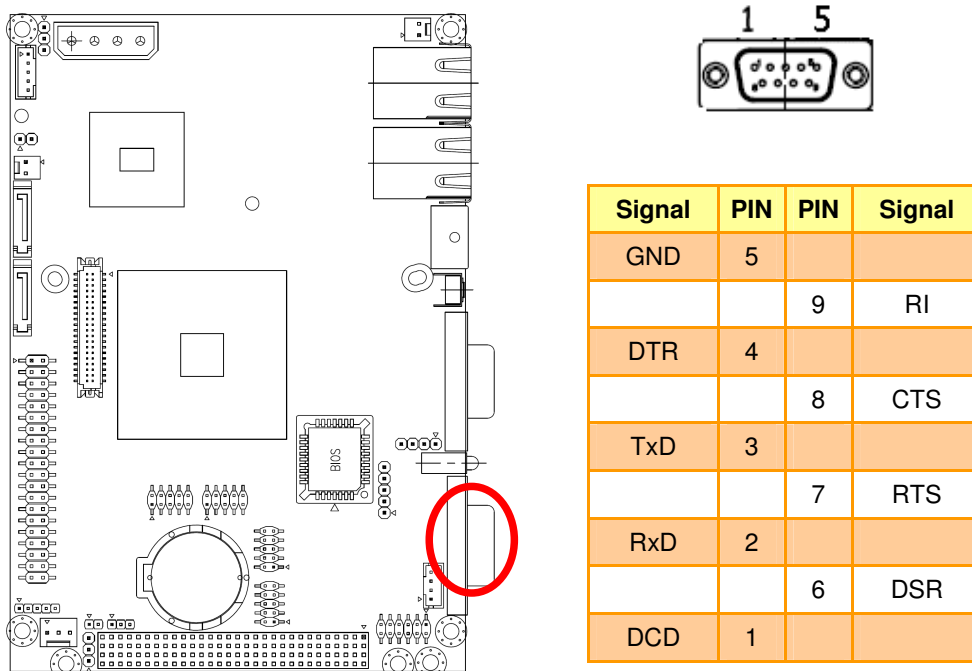

### 2.4.6.1 Signal Description – Serial Port 1 Connector (JCOM1)

| Signal | Signal Description   |
|--------|--|
| TxD    | Serial output. This signal sends serial data to the communication link. The signal is set to a marking state on hardware reset when the transmitter is empty or when loop mode operation is initiated. |
| RxD    | Serial input. This signal receives serial data from the communication link.  |
| DTR    | Data Terminal Ready. This signal indicates to the modem or data set that the on-board UART is ready to establish a communication link.   |
| DSR    | Data Set Ready. This signal indicates that the modem or data set is ready to establish a communication link.   |
| RTS    | Request To Send. This signal indicates to the modem or data set that the on-board UART is ready to exchange data.  |
| CTS    | Clear To Send. This signal indicates that the modem or data set is ready to exchange data.   |
| DCD    | Data Carrier Detect. This signal indicates that the modem or data set has detected the data carrier.   |
| RI     | Ring Indicator. This signal indicates that the modem has received a telephone ringing signal.  |

### 2.4.7 Serial Port 2 Connector in RS-232 Mode (JCOM2)

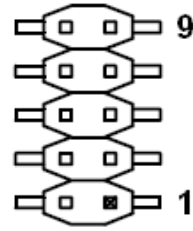
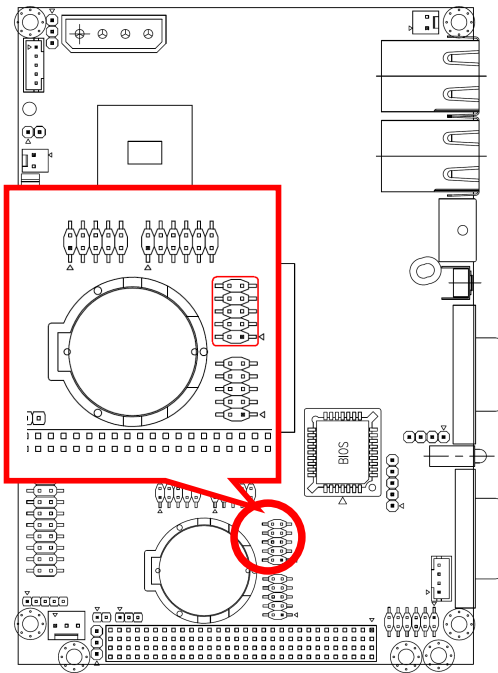

| Signal | PIN | PIN | Signal |
|--------|-----|-----|--------|
| GND    | 10  | 9   | RI     |
| CTS    | 8   | 7   | RTS    |
| DSR    | 6   | 5   | GND    |
| DRT    | 4   | 3   | TxD    |
| RxD    | 2   | 1   | DCD    |

### 2.4.8 Serial Port 2 Connector in RS-422 Mode (JCOM2)

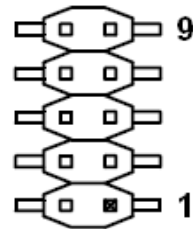
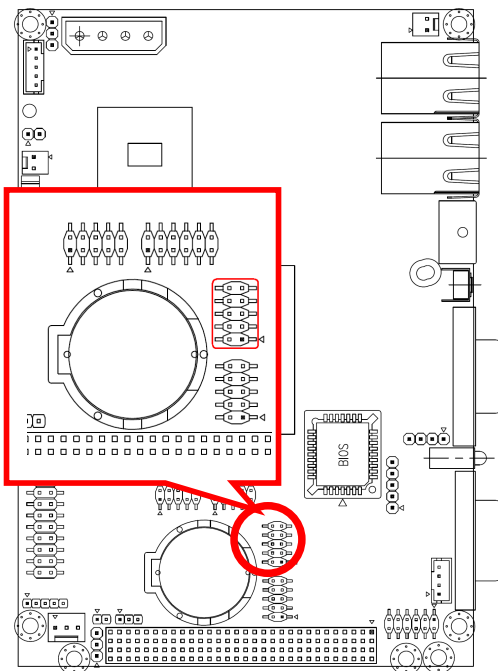

| Signal | PIN | PIN | Signal |
|--------|-----|-----|--------|
| GND    | 10  | 9   | GND    |
| RxD-   | 8   | 7   | NC     |
| TxD+   | 6   | 5   | GND    |
| NC     | 4   | 3   | NC     |
| RxD+   | 2   | 1   | TxD-   |

# ECM-CX700

## 2.4.9 Serial Port 2 Connector in RS-485 Mode (JCOM2)

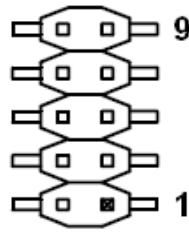
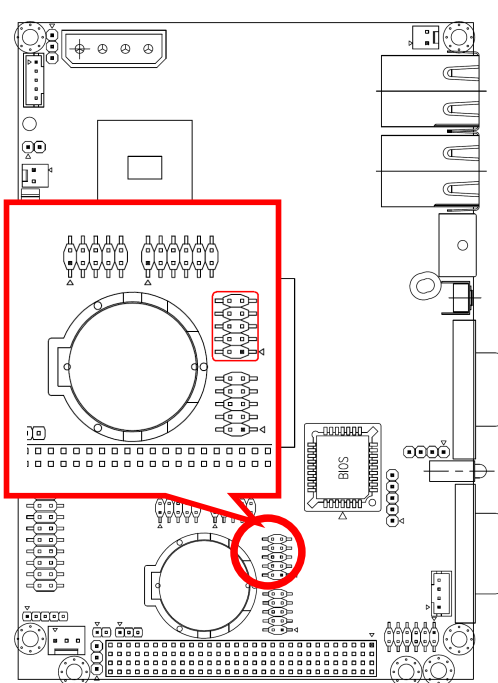

| Signal | PIN | PIN | Signal |
|--------|-----|-----|--------|
| GND    | 10  | 9   | GND    |
| NC     | 8   | 7   | NC     |
| DATA+  | 6   | 5   | GND    |
| NC     | 4   | 3   | NC     |
| NC     | 2   | 1   | DATA-  |

### 2.4.9.1 Signal Description – Serial Port 2 Connector (JCOM2)

| Signal  | Signal Description  |
|---------|---|
| TxD     | Serial output. This signal sends serial data to the communication link. The signal is set to a marking state on hardware reset when the transmitter is empty or when loop mode operation is initiated.  |
| RxD     | Serial input. This signal receives serial data from the communication link.   |
| DTR     | Data Terminal Ready. This signal indicates to the modem or data set that the on-board UART is ready to establish a communication link.  |
| DSR     | Data Set Ready. This signal indicates that the modem or data set is ready to establish a communication link.  |
| RTS     | Request To Send. This signal indicates to the modem or data set that the on-board UART is ready to exchange data.   |
| CTS     | Clear To Send. This signal indicates that the modem or data set is ready to exchange data.  |
| DCD     | Data Carrier Detect. This signal indicates that the modem or data set has detected the data carrier.  |
| RI      | Ring Indicator. This signal indicates that the modem has received a telephone ringing signal.   |
| TxD+/-  | Serial output. This differential signal pair sends serial data to the communication link. Data is transferred from Serial Port 2 Transmit Buffer Register to the communication link, if the RTS register of the Serial Port 2 is set to LOW.                                      |
| RxD+/-  | Serial input. This differential signal pair receives serial data from the communication link. Received data is available in Serial Port 2 Receiver Buffer Register.   |
| DATA+/- | This differential signal pair sends and receives serial data to the communication link. The mode of this differential signal pair is controlled through the RTS register of Serial Port 2. Set the RTS register of the Serial Port 2 to LOW for transmitting, HIGH for receiving. |



Do not select a mode different from the one used by the connected peripheral, as this may damage CPU board and/or peripheral.

The transmitter drivers in the port are short circuit protected by a thermal protection circuit. The circuit disables the drivers when the die temperature reaches 150 °C.

RS-422 mode is typically used in point to point communication. Data and control signal pairs should be terminated in the receiver end with a resistor matching the cable impedance (typical 100-120 Ω). The resistors could be placed in the connector housing.

RS-485 mode is typically used in multi drop applications, where more than 2 units are communicating. The data and control signal pairs should be terminated in each end of the communication line with a resistor matching the cable impedance (typical 100-120 Ω). Stubs to substations should be avoided.

# ECM-CX700

## 2.4.10 General Purpose I/O Connector (JDIO1)

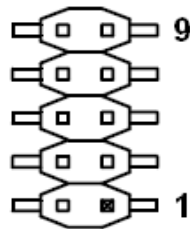
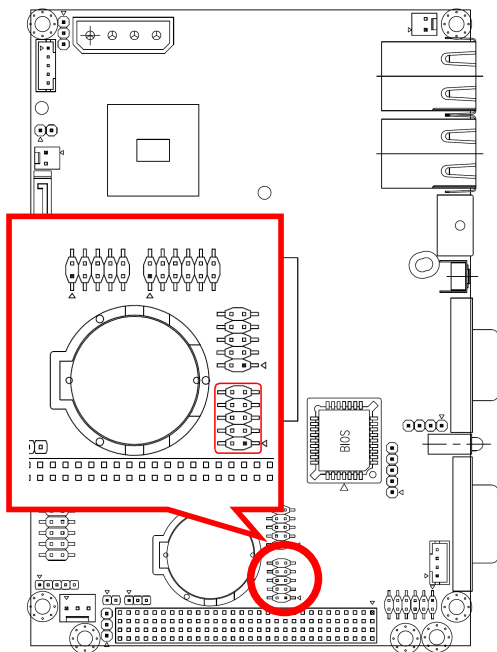

| Signal | PIN | PIN | Signal |
|--------|-----|-----|--------|
| GND    | 10  | 9   | +5V    |
| GP17   | 8   | 7   | GP13   |
| GP16   | 6   | 5   | GP12   |
| GP15   | 4   | 3   | GP11   |
| GP14   | 2   | 1   | GP10   |

### 2.4.10.1 Signal Description – General Purpose I/O Connector (JDIO1)

| Signal     | Signal Description                       |
|------------|--|
| GP [10:17] | Digital Input/Output Data Bit 0 to Bit 8 |

## 2.4.11 System Fan Connector (JFAN1&2)

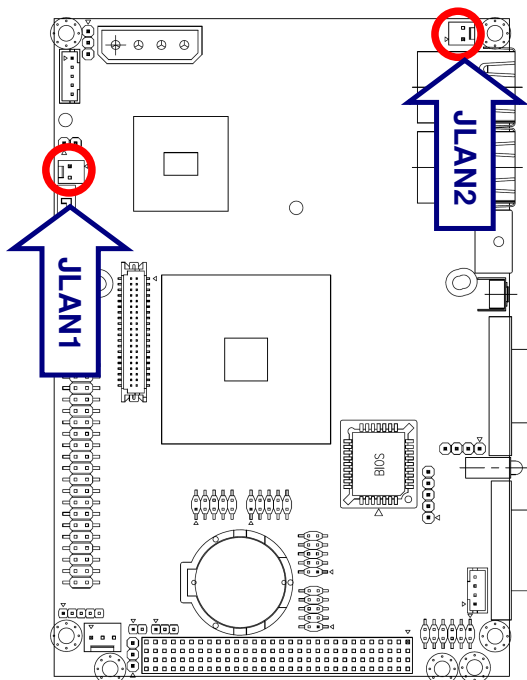

JFAN1

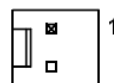

| Signal | PIN |
|--------|-----|
| GND    | 1   |
| VDD    | 2   |

JFAN2

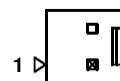

2.4.12 Primary IDE Connector (JIDE1)

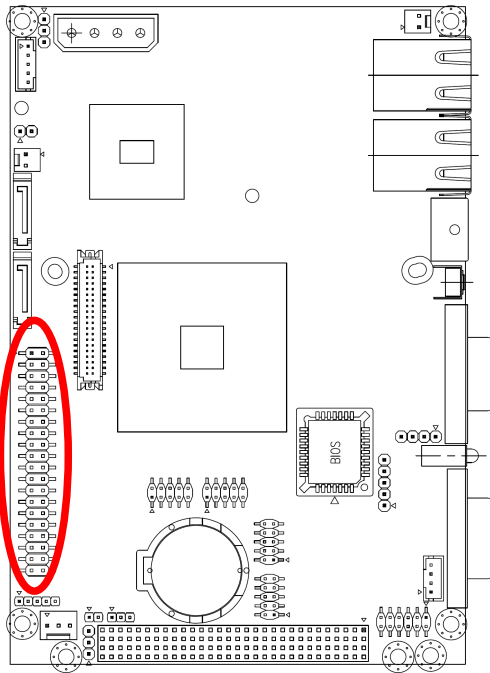

| Signal  | PIN | PIN | Signal |
|---------|-----|-----|--------|
| RESET#  | 1   | 2   | GND    |
| PDD7    | 3   | 4   | PDD8   |
| PDD6    | 5   | 6   | PDD9   |
| PDD5    | 7   | 8   | PDD10  |
| PDD4    | 9   | 10  | PDD11  |
| PDD3    | 11  | 12  | PDD12  |
| PDD2    | 13  | 14  | PDD13  |
| PDD1    | 15  | 16  | PDD14  |
| PDD0    | 17  | 18  | PDD15  |
| GND     | 19  | 20  | NC     |
| PDREQ   | 21  | 22  | GND    |
| PDIOW#  | 23  | 24  | GND    |
| PDIOR#  | 25  | 26  | GND    |
| PIORDY  | 27  | 28  | GND    |
| PDAK#   | 29  | 30  | GND    |
| IRQ15   | 31  | 32  | NC     |
| PDA1    | 33  | 34  | LID    |
| PDA0    | 35  | 36  | PDA2   |
| PDCS1#  | 37  | 38  | PDCS3# |
| HD_LED1 | 39  | 40  | GND    |

## ECM-CX700

### 2.4.12.1 Signal Description – Primary IDE Connector (JIDE1)

| Signal       | Signal Description   |
|--------------|--|
| PDA [2:0]    | IDE Address Bits. These address bits are used to access a register or data port in a device on the IDE bus.  |
| DCS1#, DCS3# | IDE Chip Selects. The chip select signals are used to select the command block registers in an IDE device. DCS1# selects the primary hard disk.                      |
| PDD [15:0]   | IDE Data Lines. D [15:0] transfers data to/from the IDE devices.   |
| PIOR#        | IDE I/O Read. Signal is asserted on read accesses to the corresponding IDE port addresses.   |
| PIOW#        | IDE I/O Write. Each signal is asserted on write accesses to corresponding the IDE port addresses.  |
| PIORDY       | When deasserted, these signals extend the transfer cycle of any host register access when the device is not ready to respond to the data transfer request.           |
| RESET#       | IDE Reset. This signal resets all the devices that are attached to the IDE interface.  |
| PIRQ15       | Interrupt line from hard disk. Connected directly to PC-AT bus.  |
| PDREQ        | The DREQ is used to request a DMA transfer from the South Bridge. The direction of the transfers is determined by the IOR#/IOW# signals.                             |
| PDACK#       | DMA Acknowledge. The DACK# acknowledges the DREQ request to initiate DMA transfers.  |
| PDACT#       | Signal from hard disk indicating hard disk activity. The signal level depends on the hard disk type, normally active low. The signal is routed directly to the LED1. |



### 2.4.13 LCD Inverter Connector (JINV1)

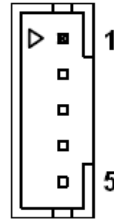
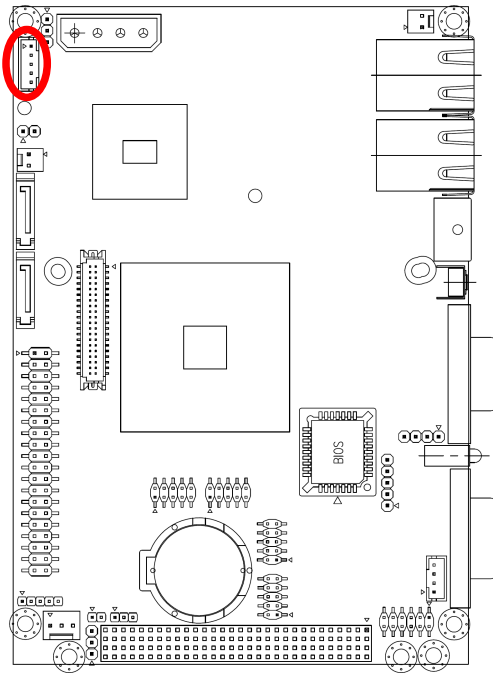

| Signal | PIN |
|--------|-----|
| +12V   | 1   |
| GND    | 2   |
| ENBKL  | 3   |
| VR     | 4   |
| +5V    | 5   |



**Note:**

For inverters with adjustable Backlight function, it is possible to control the LCD brightness through the VR signal controlled by **JVR1**. Please see the **JVR1** section for detailed circuitry information.

#### 2.4.13.1 Signal Description – LCD Inverter Connector (JINV1)

| Signal | Signal Description   |
|--------|--|
| VR     | $V_{adj} = 0.75V \sim 4.25V$ (Recommended: $4.7K\Omega$ , $>1/16W$ ) |
| ENBKL  | LCD backlight ON/OFF control signal                                  |

# ECM-CX700

## 2.4.14 IrDA Connector (JIR1)

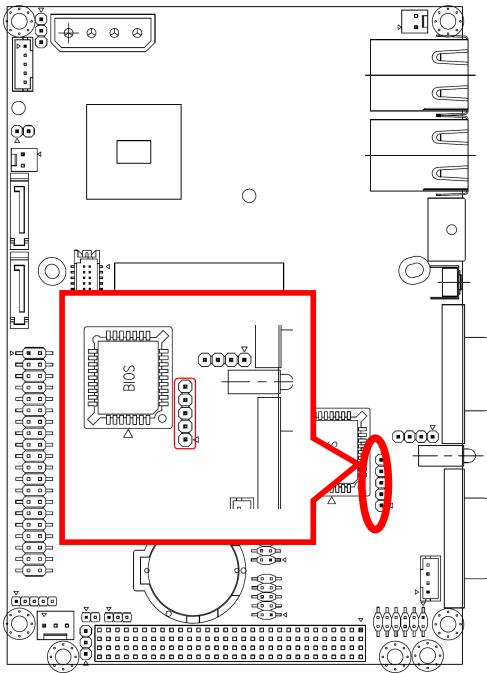

| Signal | PIN |
|--------|-----|
| IRTX   | 5   |
| GND    | 4   |
| IRRX   | 3   |
| NC     | 2   |
| +5V    | 1   |

### 2.4.14.1 Signal Description – IrDA Connector (JIR1)

| Signal | Signal Description          |
|--------|-----------------------------|
| IRRX   | Infrared Receiver input     |
| IRTX   | Infrared Transmitter output |

**2.4.15 PS/2 Keyboard & Mouse Connector (JKB1)**

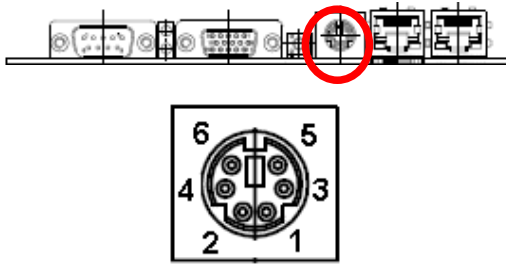

| Signal | PIN | PIN | Signal |
|--------|-----|-----|--------|
| MDAT   | 6   | 5   | KDAT   |
| GND    | 4   | 3   | +5V    |
| KCLK   | 2   | 1   | MCLK   |

**2.4.15.1 Signal Description – PS/2 Keyboard & Mouse Connector (JKB1)**

| Signal | Signal Description  |
|--------|---|
| KCLK   | Bi-directional clock signal used to strobe data/commands from/to the PC-AT keyboard.          |
| KDAT   | Bi-directional serial data line used to transfer data from or commands to the PC-AT keyboard. |
| MCLK   | Bi-directional clock signal used to strobe data/commands from/to the PS/2 mouse.              |
| MDAT   | Bi-directional serial data line used to transfer data from or commands to the PS/2 mouse.     |

**2.4.16 RJ-45 Ethernet (JLAN1, JLAN2)**

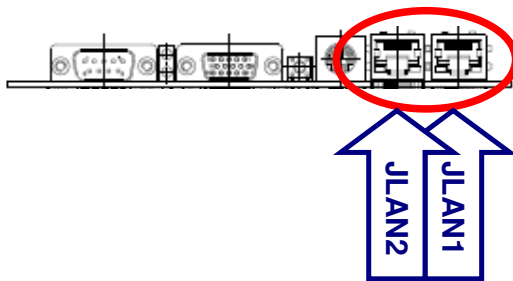

| Port  | Description  |
|-------|--|
| RJ-45 | Allows connection to a Local Area Network (LAN) through a network hub. |

# ECM-CX700

## 2.4.17 LVDS Connector (JLVDS1)

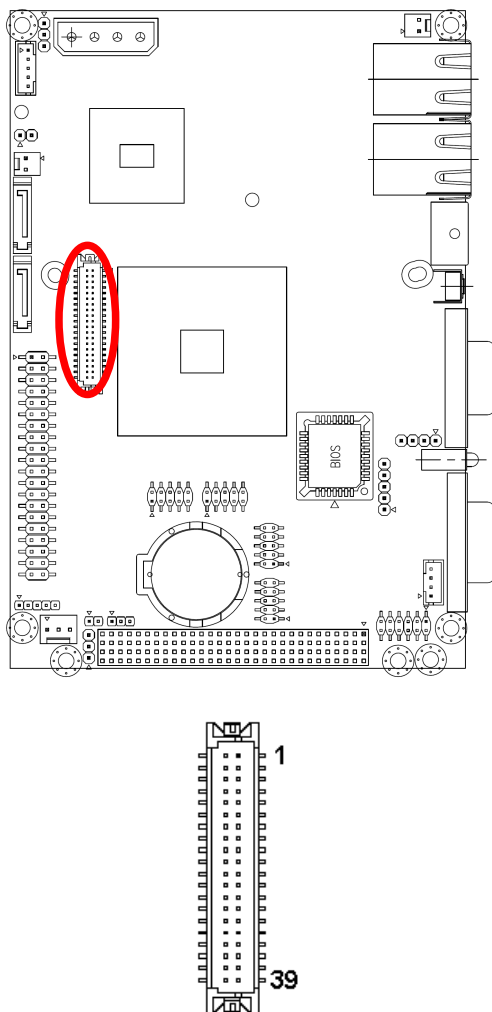

| Signal               | PIN | PIN | Signal               |
|----------------------|-----|-----|----------------------|
| +5V                  | 2   | 1   | +3.3V                |
| +5V                  | 4   | 3   | +3.3V                |
| I <sup>2</sup> C_DAT | 6   | 5   | I <sup>2</sup> C_CLK |
| GND                  | 8   | 7   | GND                  |
| Txout0               | 10  | 9   | Txout1               |
| Txout0#              | 12  | 11  | Txout1#              |
| GND                  | 14  | 13  | GND                  |
| Txout2               | 16  | 15  | Txout3               |
| Txout2#              | 18  | 17  | Txout3#              |
| GND                  | 20  | 19  | GND                  |
| E_Txout0             | 22  | 21  | E_Txout1             |
| E_Txout0#            | 24  | 23  | E_Txout1#            |
| GND                  | 26  | 25  | GND                  |
| E_Txout2             | 28  | 27  | E_Txout3             |
| E_Txout2#            | 30  | 29  | E_Txout3#            |
| GND                  | 32  | 31  | GND                  |
| Txclk                | 34  | 33  | E_Txclk              |
| Txclk#               | 36  | 35  | E_Txclk#             |
| GND                  | 38  | 37  | GND                  |
| DVI/DAT              | 40  | 39  | DVI/CLK              |

### 2.4.17.1 Signal Description – LVDS Connector (JLVDS1)

| Signal                                     | Description  |
|--|--|
| I <sup>2</sup> C_DAT, I <sup>2</sup> C_CLK | I <sup>2</sup> C interface for panel parameter EEPROM. This EEPROM is mounted on the LVDS receiver. The data in the EEPROM allows the EXT module to automatically set the proper timing parameters for a specific LCD panel. |

### 2.4.18 ATX Power Switch Connector (JPS1)

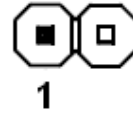
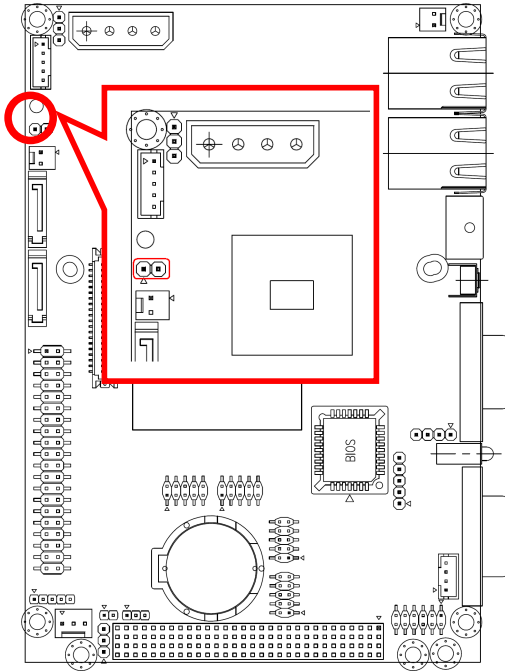

| Signal | PIN |
|--------|-----|
| GND    | 2   |
| PW_BN  | 1   |

### 2.4.19 Power Connector (JPWR1)

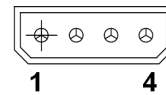
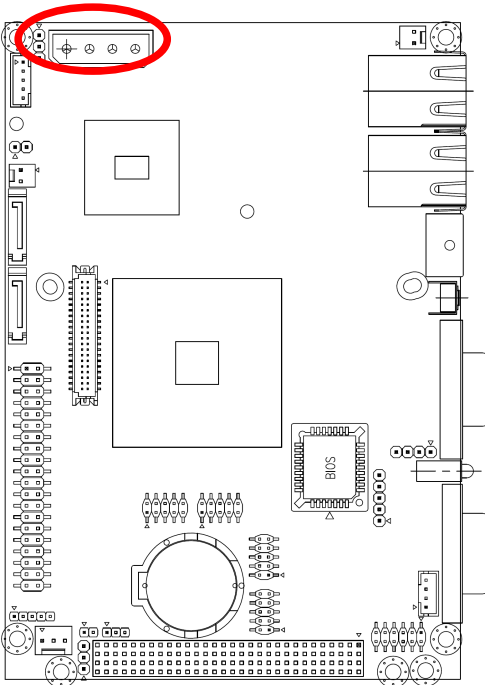

| PIN | Signal |
|-----|--------|
| 1   | +12V   |
| 2   | GND    |
| 3   | GND    |
| 4   | +5V    |

# ECM-CX700

## 2.4.20 TV Connector (JTV1)

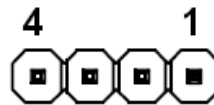
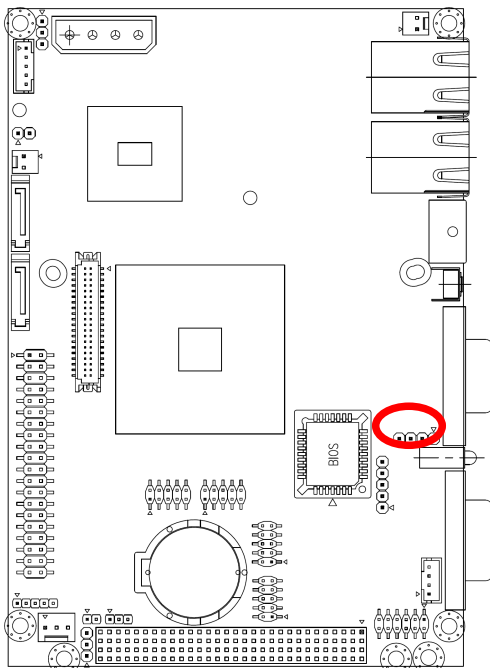

| Signal    | PIN |
|-----------|-----|
| R/Pr/C    | 1   |
| G/Y       | 2   |
| B/Pb/CVBS | 3   |
| GND       | 4   |

| DAC Output Mode |      |    |    |
|-----------------|------|----|----|
| AV-signal       | CVBS |    |    |
| S-video         | Y    | C  |    |
| TV-Signal       | R    | G  | B  |
| Y Pb Pr         | Y    | Pb | Pr |
| Y Cb Cr         | Y    | Pb | Pr |

## 2.4.21 USB Connector 0 & 1 (JUSB1)

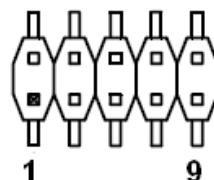
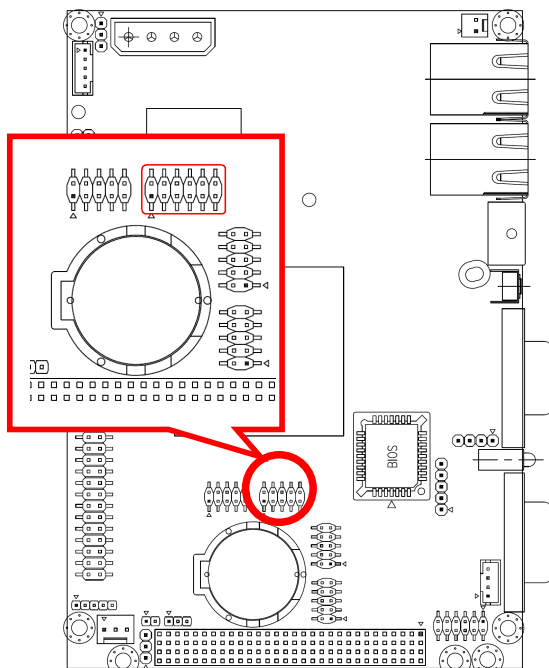

| Signal | PIN | PIN | Signal |
|--------|-----|-----|--------|
| +5V    | 1   | 2   | GND    |
| D1-    | 3   | 4   | GND    |
| D1+    | 5   | 6   | D0+    |
| GND    | 7   | 8   | D0-    |
| GND    | 9   | 10  | +5V    |



# ECM-CX700

## 2.4.22 USB Connector 2 & 3 (JUSB2)

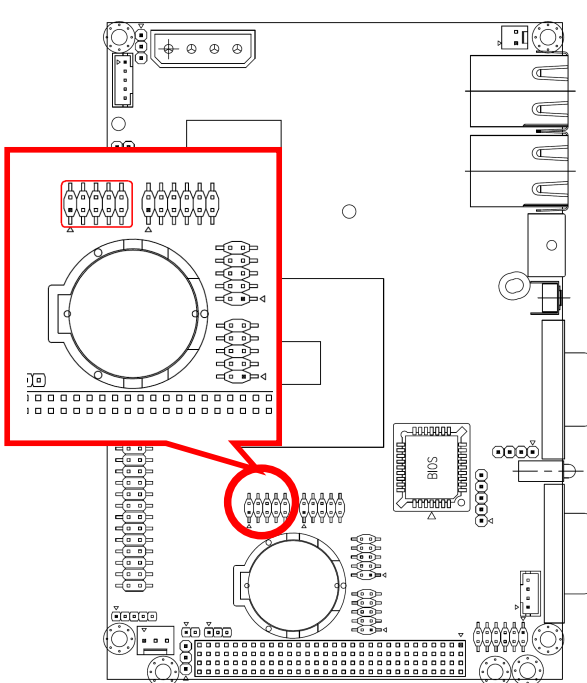

| Signal | PIN | PIN | Signal |
|--------|-----|-----|--------|
| +5V    | 1   | 2   | GND    |
| D3-    | 3   | 4   | GND    |
| D3+    | 5   | 6   | D2+    |
| GND    | 7   | 8   | D2-    |
| GND    | 9   | 10  | +5V    |

### 2.4.22.1 Signal Description – USB Connector 0, 1, 2 & 3 Connector (JUSB1, JUSB2)

| Signal       | Signal Description   |
|--------------|--|
| D0+/-, D2+/- | Differential bi-directional data signal for USB channel 0, 2. Clock is transmitted along with the data using NRZI encoding. The signalling bit rate is up to 12 Mbs. |
| D1+/-, D3+/- | Differential bi-directional data signal for USB channel 1, 3. Clock is transmitted along with the data using NRZI encoding. The signalling bit rate is up to 12 Mbs. |



2.4.23 VGA Connector (JVGA1)

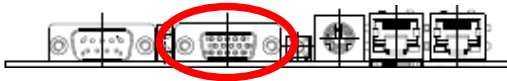

| Signal | PIN |    | Signal |
|--------|-----|----|--------|
|        |     | 6  | GND    |
| RED    | 1   | 11 | NC     |
|        |     | 7  | GND    |
| GREEN  | 2   | 12 | DAT    |
|        |     | 8  | GND    |
| BLUE   | 3   | 13 | HSYNC  |
|        |     | 9  | VCC    |
| NC     | 4   | 14 | VSYNC  |
|        |     | 10 | GND    |
| GND    | 5   | 15 | DCK    |

2.4.23.1 Signal Description – VGA Connector (JVGA1)

| Signal | Signal Description  |
|--------|---|
| HSYNC  | CRT horizontal synchronisation output.  |
| VSYNC  | CRT vertical synchronisation output.  |
| DCK    | Display Data Channel Clock. Used as clock signal to/from monitors with DDC interface.       |
| DAT    | Display Data Channel Data. Used as data signal to/from monitors with DDC interface.         |
| RED    | Analog output carrying the red colour signal to the CRT. For 75 $\Omega$ cable impedance.   |
| GREEN  | Analog output carrying the green colour signal to the CRT. For 75 $\Omega$ cable impedance. |
| BLUE   | Analog output carrying the blue colour signal to the CRT. For 75 $\Omega$ cable impedance.  |

# ECM-CX700

## 2.4.24 LCD Backlight Brightness Adjustment Connector (JVR1)

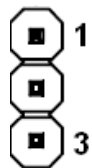
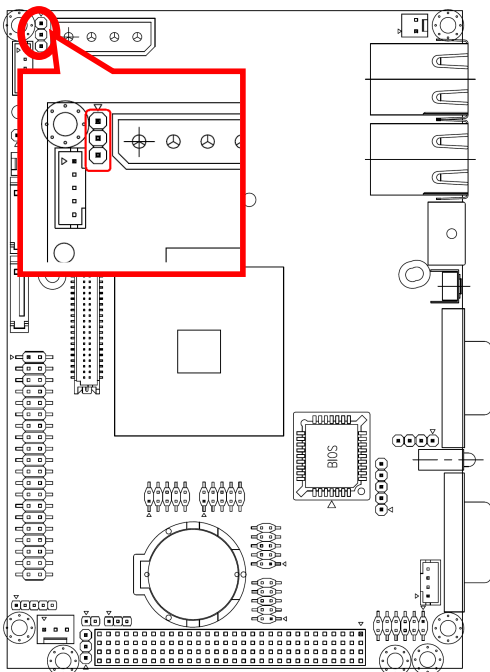

| Signal | PIN |
|--------|-----|
| GND    | 1   |
| VR     | 2   |
| +5V    | 3   |

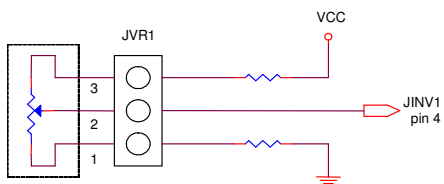

Variation Resistor  
(Recommended: 4.7KΩ, >1/16W)

# 3. BIOS Setup

---

### **3.1 Starting Setup**

The AwardBIOS™ is immediately activated when you first power on the computer. The BIOS reads the system information contained in the CMOS and begins the process of checking out the system and configuring it. When it finishes, the BIOS will seek an operating system on one of the disks and then launch and turn control over to the operating system.

While the BIOS is in control, the Setup program can be activated in one of two ways:

By pressing <Del> immediately after switching the system on, or

By pressing the <Del> key when the following message appears briefly at the bottom of the screen during the POST (Power On Self Test).

**Press DEL to enter SETUP**

If the message disappears before you respond and you still wish to enter Setup, restart the system to try again by turning it OFF then ON or pressing the "RESET" button on the system case. You may also restart by simultaneously pressing <Ctrl>, <Alt>, and <Delete> keys. If you do not press the keys at the correct time and the system does not boot, an error message will be displayed and you will again be asked to.

**Press F1 to Continue, DEL to enter SETUP**

## 3.2 Using Setup

In general, you use the arrow keys to highlight items, press <Enter> to select, use the PageUp and PageDown keys to change entries, press <F1> for help and press <Esc> to quit. The following table provides more detail about how to navigate in the Setup program using the keyboard.

| Button         | Description  |
|----------------|--|
| ↑              | Move to previous item  |
| ↓              | Move to next item  |
| ←              | Move to the item in the left hand  |
| →              | Move to the item in the right hand   |
| Esc key        | Main Menu -- Quit and not save changes into CMOS<br>Status Page Setup Menu and Option Page Setup Menu -- Exit current page and return to Main Menu |
| PgUp key       | Increase the numeric value or make changes   |
| PgDn key       | Decrease the numeric value or make changes   |
| + key          | Increase the numeric value or make changes   |
| - key          | Decrease the numeric value or make changes   |
| F1 key         | General help, only for Status Page Setup Menu and Option Page Setup Menu   |
| (Shift) F2 key | Change color from total 16 colors. F2 to select color forward, (Shift) F2 to select color backward   |
| F3 key         | Calendar, only for Status Page Setup Menu  |
| F4 key         | Reserved   |
| F5 key         | Restore the previous CMOS value from CMOS, only for Option Page Setup Menu   |
| F6 key         | Load the default CMOS value from BIOS default table, only for Option Page Setup Menu   |
| F7 key         | Load the default   |
| F8 key         | Reserved   |
| F9 key         | Reserved   |
| F10 key        | Save all the CMOS changes, only for Main Menu  |

- **Navigating Through The Menu Bar**

Use the left and right arrow keys to choose the menu you want to be in.



**Note:** Some of the navigation keys differ from one screen to another.

## ECM-CX700

- **To Display a Sub Menu**

Use the arrow keys to move the cursor to the sub menu you want. Then press <Enter>. A “>” pointer marks all sub menus.

### 3.3 Getting Help

Press F1 to pop up a small help window that describes the appropriate keys to use and the possible selections for the highlighted item. To exit the Help Window press <Esc> or the F1 key again.

### 3.4 In Case of Problems

If, after making and saving system changes with Setup, you discover that your computer no longer is able to boot, the AwardBIOS™ supports an override to the CMOS settings which resets your system to its defaults.

The best advice is to only alter settings which you thoroughly understand. To this end, we strongly recommend that you avoid making any changes to the chipset defaults. These defaults have been carefully chosen by both Award and your systems manufacturer to provide the absolute maximum performance and reliability. Even a seemingly small change to the chipset setup has the potential for causing you to use the override.

### 3.5 Main Menu

Once you enter the AwardBIOS™ CMOS Setup Utility, the Main Menu will appear on the screen. The Main Menu allows you to select from several setup functions and two exit choices. Use the arrow keys to select among the items and press <Enter> to accept and enter the sub-menu.

Note that a brief description of each highlighted selection appears at the bottom of the screen.

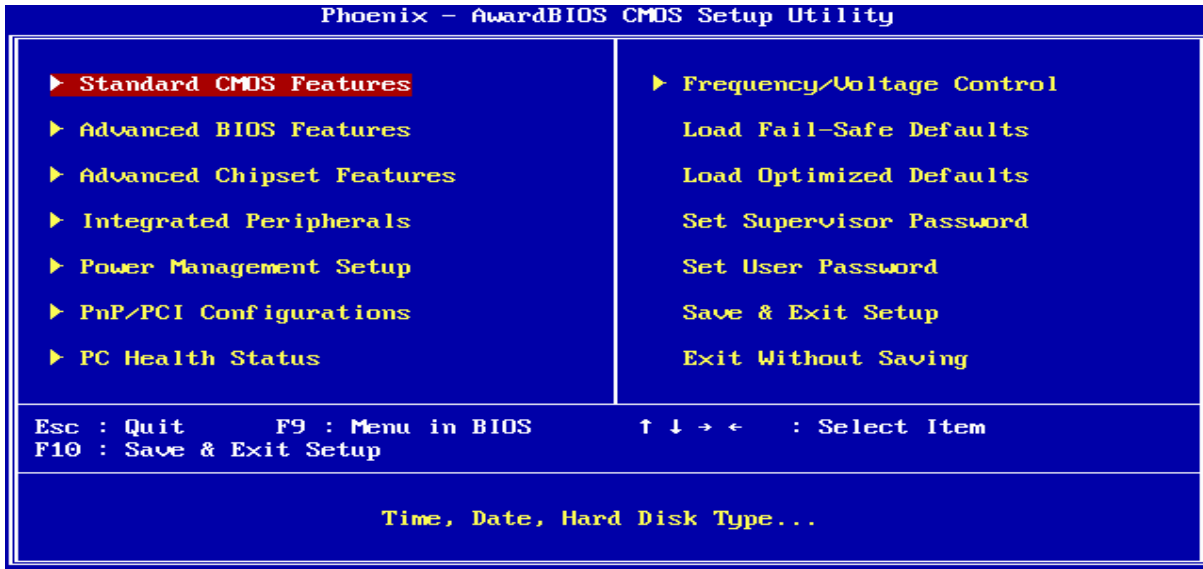

**Note:** The BIOS setup screens shown in this chapter are for reference purposes only, and may not exactly match what you see on your screen. Visit the Avalue website ([www.avalu.com.tw](http://www.avalu.com.tw)) to download the latest product and BIOS information.

## ECM-CX700

### 3.5.1 Standard CMOS Features

The items in Standard CMOS Setup Menu are divided into few categories. Each category includes no, one or more than one setup items. Use the arrow keys to highlight the item and then use the <PgUp> or <PgDn> keys to select the value you want in each item.

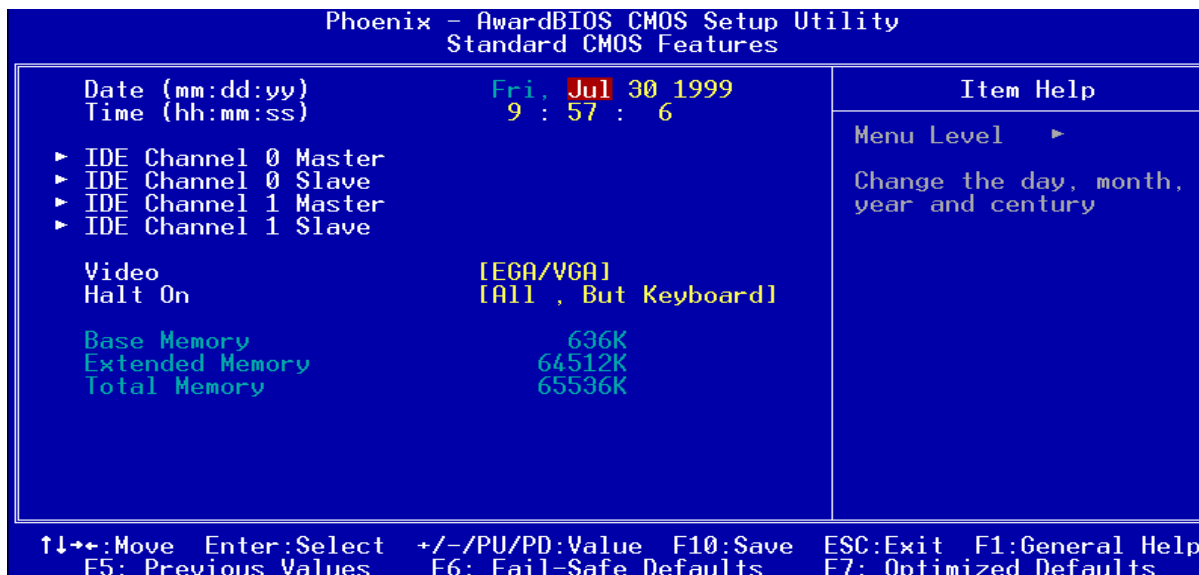

#### 3.5.1.1 Main Menu Selection

This reference table shows the selections that you may make on the Main Menu.

| Item   | Options  | Description   |
|--|--|---|
| Date   | MM DD YYYY   | Set the system date. Note that the 'Day' automatically changes when you set the date    |
| Time   | HH : MM : SS   | Set the system time   |
| IDE Channel 0 Master<br>IDE Channel 0 Slave<br>IDE Channel 1 Master<br>IDE Channel 1 Slave | Options are in 3.5.1.2   | Press <Enter> to enter the sub menu of detailed options                                 |
| Video  | EGA/VGA<br>CGA 40<br>CGA 80<br>MONO  | Select the default video device   |
| Halt On  | All Errors<br>No Errors<br>All, but Keyboard<br>All, but Diskette<br>All, but Disk/Key | Select the situation in which you want the BIOS to stop the POST process and notify you |



### 3.5.1.2 IDE Adapter Setup

The IDE adapters control the hard disk drive. Use a separate sub menu to configure each hard disk drive. The below Figure will shows the IDE primary master sub menu.

| Item   | Options                        | Description  |
|--|--------------------------------|--|
| IDE HDD Auto-detection   | Press Enter                    | Press Enter to auto-detect the HDD on this channel. If detection is successful, it fills the remaining fields on this menu.  |
| IDE Channel 0 Master<br>IDE Channel 0 Slave,<br>IDE Channel 1 Master,<br>IDE Channel 1 Slave | None<br>Auto<br>Manual         | Selecting 'manual' lets you set the remaining fields on this screen. Selects the type of fixed disk. "User Type" will let you select the number of cylinders, heads, etc. Note: PRECOMP=65535 means NONE ! |
| Access Mode  | Normal<br>LBA<br>Large<br>Auto | Choose the access mode for this hard disk  |
| The following options are selectable only if the 'IDE Channel ...' item is set to 'Manual'   |                                |  |
| Cylinder   | Min = 0<br>Max = 65535         | Set the number of cylinders for this hard disk.  |
| Head   | Min = 0<br>Max = 255           | Set the number of read/write heads   |
| Precomp  | Min = 0<br>Max = 65535         | **** <b>Warning:</b> Setting a value of 65535 means no hard disk   |
| Landing zone   | Min = 0<br>Max = 65535         | ****   |
| Sector   | Min = 0<br>Max = 255           | Number of sectors per track  |

## ECM-CX700

### 3.5.2 Advanced BIOS Features

This section allows you to configure your system for basic operation. You have the opportunity to select the system's default speed, boot-up sequence, keyboard operation, shadowing and security.

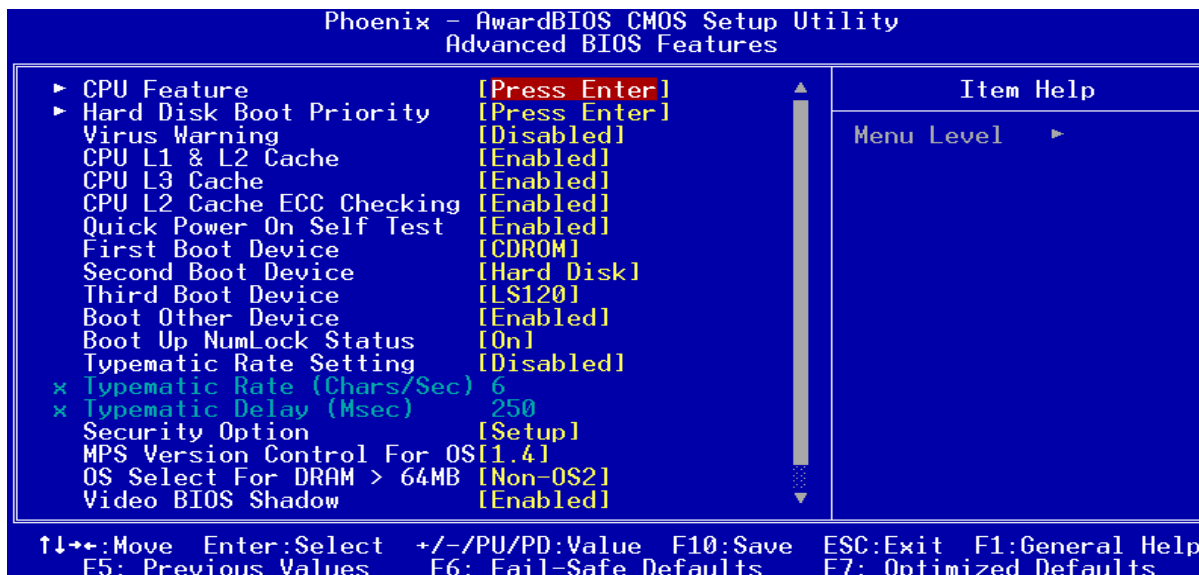

#### 3.5.2.1 CPU Features

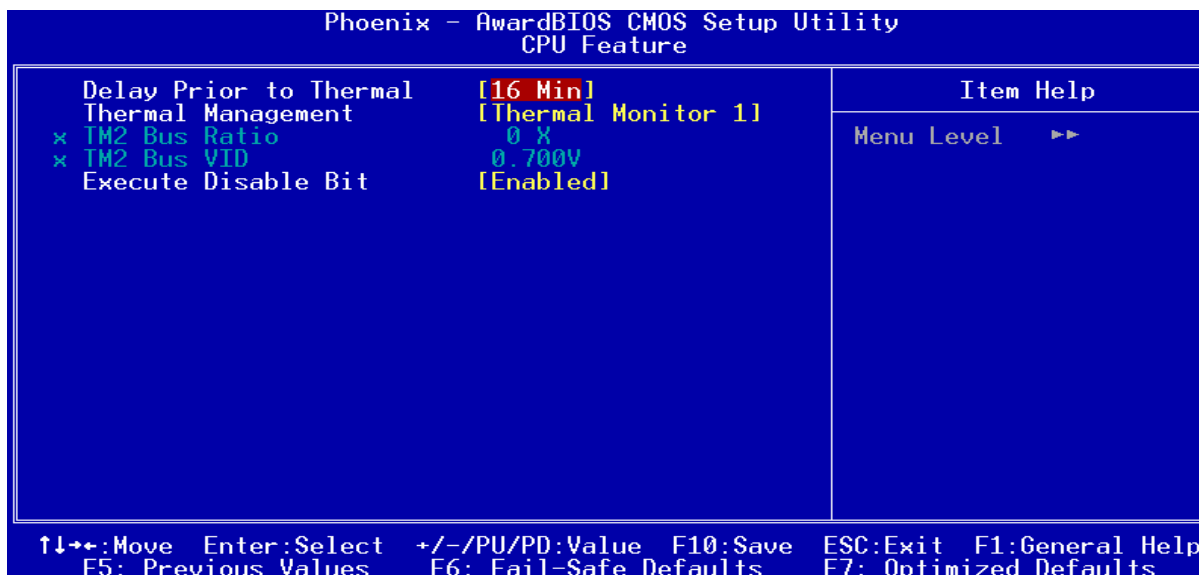

| Item                   | Options                                | Description  |
|------------------------|--|--|
| Delay Prior to Thermal | 4 Min, 8 Min, 16 Min, 32 Min           | This item is to set whether to run Delay Prior to Thermal.         |
| Thermal Management     | Thermal Monitor 1<br>Thermal Monitor 2 | Allow you to choose the thermal management method of your monitor. |
| Execute Disable Bit    | Enabled, Disabled                      | To stop buffer overflow attacks against the operating system.      |

### 3.5.2.2 Hard Disk boot Priority

This item allows you to select the Hard Disk device boot up priority.

| Item                  | Description                                      |
|-----------------------|--|
| Pri.Master            | Boot up from IDE Primary Master Hard Disk        |
| Pri.Slave             | Boot up from IDE Primary Slave Hard Disk         |
| Sec.Master            | Boot up from IDE Secondary Master Hard Disk      |
| Sec.Slave             | Boot up from IDE Secondary Slave Hard Disk       |
| USBHDD0               | Boot up from First USB Hard Disk                 |
| USBHDD1               | Boot up from Second USB Hard Disk                |
| USBHDD2               | Boot up from Thrid USB Hard Disk                 |
| Bootable Add-in Cards | Boot up from other Add-In Card Hard Disk Device. |

### 3.5.2.3 Virus Warning

Allows you to choose the VIRUS Warning feature for IDE Hard Disk boot sector protection. If this function is enabled and someone attempt to write data into this area, BIOS will show a warning message on screen and alarm beep.

| Item     | Description   |
|----------|---|
| Enabled  | Activates automatically when the system boots up causing a warning message to appear when anything attempts to access the boot sector or hard disk partition table. |
| Disabled | No warning message will appear when anything attempts to access the boot sector or hard disk partition table.   |

### 3.5.2.4 CPU L1 ,L2 & L3 Cache

Depending on the CPU/chipset in use, you may be able to increase memory access time with this option.

| Item     | Description   |
|----------|---------------|
| Enabled  | Enable cache  |
| Disabled | Disable cache |

### 3.5.2.5 CPU L2 Cache ECC Checking

This item allows you to enable the CPU external L2 cache use ECC checking method in memory access.

| Item     | Description          |
|----------|----------------------|
| Enabled  | Enable ECC checking  |
| Disabled | Disable ECC checking |

### 3.5.2.6 Quick Power On Self Test

This category speeds up Power On Self Test (POST) after you power up the computer. If it is set to Enable, BIOS will shorten or skip some check items during POST.

| Item     | Description       |
|----------|-------------------|
| Enabled  | Enable quick POST |
| Disabled | Normal POST       |

### 3.5.2.7 First / Second / Third / Other Boot Device

The BIOS attempts to load the operating system from the devices in the sequence selected in these items.

| Item       | Description              |
|------------|--------------------------|
| Floppy     | Floppy Device            |
| LS120      | LS120 Device             |
| Hard Disk  | Hard Disk Device         |
| CDROM      | CDROM Device             |
| ZIP100     | ZIP-100 Device           |
| USB-FDD    | USB Floppy Device        |
| USB-ZIP    | USB ZIP Device           |
| USB-CDROM  | USB CDROM Device         |
| Legacy LAN | Network Device           |
| Disabled   | Disabled any boot device |

### 3.5.2.8 Boot Up NumLock Status

Select power on state for NumLock.

| Item     | Description     |
|----------|-----------------|
| Enabled  | Enable NumLock  |
| Disabled | Disable NumLock |

### 3.5.2.9 Typematic Rate Setting

Key strokes repeat at a rate determined by the keyboard controller. When enabled, the typematic rate and typematic delay can be selected.

| Item     | Description                          |
|----------|--------------------------------------|
| Enabled  | Enable typematic rate/delay setting  |
| Disabled | Disable typematic rate/delay setting |

### 3.5.2.10 Typematic Rate (Chars/Sec)

Sets the number of times a second to repeat a key stroke when you hold the key down. The choice: 6, 8, 10, 12, 15, 20, 24, 30.

### 3.5.2.11 Typematic Delay (Msec)

Sets the delay time after the key is held down before it begins to repeat the keystroke. The choice: 250, 500, 750, 1000.

### 3.5.2.12 Security Option

Select whether the password is required every time the system boots or only when you enter setup.

| Item   | Description   |
|--------|---|
| System | The system will not boot and access to Setup will be denied if the correct password is not entered at the prompt. |
| Setup  | The system will boot, but access to Setup will be denied if the correct password is not entered at the prompt.    |



**Note:** To disable security, select PASSWORD SETTING at Main Menu and then you will be asked to enter password. Do not type anything and just press <Enter>, it will disable security. Once the security is disabled, the system will boot and you can enter Setup freely.

**3.5.2.13 MPS Version Control For OS**

This feature is only applicable to multiprocessor board as it specifies the version of the Multi-Processor Specification (MPS) that the board will use.

The choice: 1.4, 1.1.

**3.5.2.14 OS Select for DRAM > 64MB**

Select the operating system that is running with greater than 64MB of RAM on the system.

| Item    | Description                    |
|---------|--------------------------------|
| Non-OS2 | Disable OS for over 64 MB DRAM |
| OS2     | Enable OS for over 64 MB DRAM  |

**3.5.2.15 Video BIOS Shadow**

To allow copying Video BIOS into shadow RAM to improve video performance.

| Item    | Description                            |
|---------|--|
| Enable  | Copy Video BIOS into shadow RAM        |
| Disable | Do not copy Video BIOS into shadow RAM |

**3.5.2.16 Full Screen LOGO Show**

If the BIOS had the full screen logo in it, this item could allow enable/ disable the full screen logo show on display.

| Item    | Description                   |
|---------|-------------------------------|
| Enable  | Enable full screen logo show  |
| Disable | Disable full screen logo show |

**3.5.2.17 Small Logo (EPA) Show**

This item allows you enabled/disabled the small EPA logo show on screen at the POST step.

| Item     | Description               |
|----------|---------------------------|
| Enabled  | EPA Logo show is enabled  |
| Disabled | EPA Logo show is disabled |

## ECM-CX700

### 3.5.3 Advanced Chipset Features

This section allows you to configure the system based on the specific features of the installed chipset. This chipset manages bus speeds and access to system memory resources, such as DRAM and the external cache. It also coordinates communications between the conventional ISA bus and the PCI bus. It must be stated that these items should never need to be altered. The default settings have been chosen because they provide the best operating conditions for your system. The only time you might consider making any changes would be if you discovered that data was being lost while using your system.

The first chipset settings deal with CPU access to dynamic random access memory (DRAM). The default timings have been carefully chosen and should only be altered if data is being lost. Such a scenario might well occur if your system had mixed speed DRAM chips installed so that greater delays may be required to preserve the integrity of the data held in the slower memory chips.

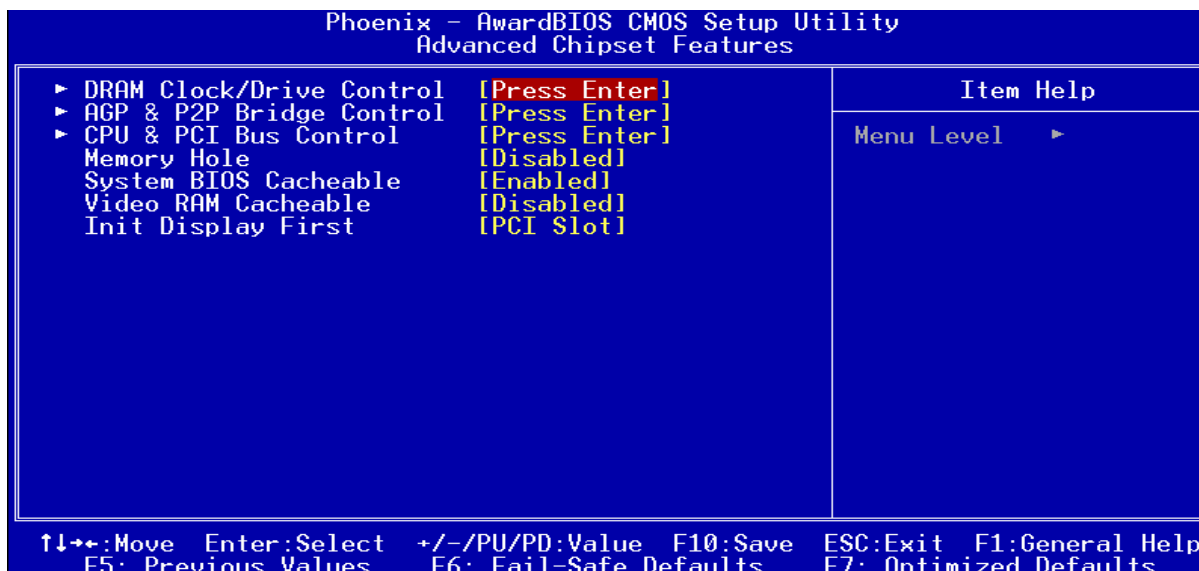

### 3.5.3.1 DRAM Clock/Drive Control

This section can set the DRAM clock/driver timing.

| Item                        | Options   | Description   |
|-----------------------------|---|---|
| DRAM Clock                  | By SPD<br>100MHz<br>133 MHz<br>166 MHz<br>200 MHz<br>266 MHz                    | Set the memory bus frequency to operate at various values for the proper memory clock setting   |
| DRAM Timing                 | Manual<br>Auto By SPD   | Set the memory timings for the said timings or DRAM Cycle Lengths of 2 or 2.5.  |
| SDRAM CAS Latency           | 1.5/2<br>2/3<br>2.5/4<br>3/5  | This controls the time delay passing before the SDRAM starts to carry out a read command after receiving it.  |
| Bank Interleave             | Disabled<br>2 Bank<br>4 Bank<br>8 Bank  | Enables to set the interleave mode of the SDRAM interface which allows banks of SDRAM to alternate their refresh and access cycles.   |
| Precharge to Active(Trp)    | 2T<br>3T<br>4T<br>5T  | This item sets the length of time taking to precharge a row in the memory module before a row being active and appears only when <b>DRAM timing</b> is set at <b>Manual</b> . Longer values are safer but probably not acting the best performance.   |
| Active to Precharge(Tras)   | 05T, 06T, 08T, 09T<br>10T, 11T, 12T, 13T<br>14T, 15T, 16T, 17T<br>18T, 19T, 20T | This item sets the length of time that a row staying active before precharging and appears only when <b>DRAM timing</b> is set at <b>Manual</b> . Longer values are safer but probably not acting the best performance.   |
| Active to CMD(Trcd)         | 2T<br>3T<br>4T<br>5T  | This timing controls the length of the delay between when a memory bank is activated to when a read/write command is sent to that bank.   |
| REF to ACT/REF to REF(Trfc) | 08T, 09T...~70T, 71T  | Set the REF to ACT/REF to REF timing. This field appears when <b>DRAM Timing</b> is set at <b>Manual</b> .  |
| ACT(0) to ACT(1) (TRRD)     | 2T<br>3T<br>4T<br>5T  | Set the minimum time interval between successive ACTIVE commands to the different banks. This field appears when <b>DRAM Timing</b> is set at <b>Manual</b> .   |
| Read to Precharge (Trtp)    | 2T<br>3T  | This bits control the number of clocks that are inserted between a read command to a row precharge command to the same rank.  |
| Writ to Read CMD (Twtr)     | 1T/2T<br>2T/3T  | Allows to set the Write to Read CMD function.   |
| Write Recovery Time (Twr)   | 2T<br>3T<br>4T<br>5T  | Write recovery time is a standard DDR2 timing parameter minimum time between a write command and subsequent precharge command to the same bank. The parameter is programmable on DDR2 SODIMMs and the value used above must match the largest delay programmed in any SODIMM in the system. |
| DRAM Command Rate           | 2T Command<br>1T Command  | Allows to set the DRAM Command Rate.  |
| RDSAIT Mode                 | Manual<br>Auto  | Allows to select RDSAIT Mode.   |
| RDSAIT Selection            | 3   | Allows to set RDSAIT selection.   |

## ECM-CX700

### 3.5.3.2 AGP & P2P Bridge Control

This item stores the onboard AGP and P2P function information. The reference table is as below.

| Item                      | Options  | Description  |
|---------------------------|--|--|
| AGP Aperture Size         | 32M,<br>64M,<br>128M,<br>256M,<br>512M,<br>1G  | Select the size of Accelerated Graphics Port (AGP) aperture. The aperture is a portion of the PCI memory address range dedicated for graphics memory address space. Host cycles that hit the aperture range are forwarded to the AGP without any translation.                          |
| AGP 2.0 Mode              | 4X,<br>2X,<br>1X   | This item allows you to select the AGP 2.0 mode to 4X,2X or 1X.  |
| AGP Driving Control       | Auto<br>Manual   | This item allows you to select the AGP Driving Control to auto / disable Mode.   |
| AGP Driving Value         | 00 ~ FF  | This item allows you to set the AGP Driving value  |
| AGP Fast Write            | Enabled<br>Disabled  | This feature controls the AGP bus's Fast Write capability. It accelerates memory write transactions from the chipset to the AGP device.  |
| AGP Master 1 WS Write     | Enabled<br>Disabled  | Enabled this item to increase AGP writing  |
| AGP Master 1 WS Read      | Enabled<br>Disabled  | Enabled this item to increase AGP reading  |
| AGP 3.0 Calibration Cycle | Enabled<br>Disabled  | This option allows you to disable the AGP 3.0 calibration cycle. This cycle ensures that the on-die termination impedance signal swing and slew rate of the AGP signals are calibrated on a periodic basis to ensure signal integrity. It is recommended to keep this setting enabled. |
| VGA Share Memory Size     | Disabled<br>16M<br>32M<br>64M  | Select the size of onboard video controller's frame buffer. The buffer size are share from system memory unit.   |
| Direct Frame Buffer       | Enabled<br>Disabled  | This item allows you to select the Direct Frame Buffer to enabled / disabled.  |
| Select Display Device     | CRT<br>LCD,<br>CRT+LCD,  | Select Display Device that the screen will be shown  |
| Panel Type                | 640x480 1x18B<br>800x600 1x18B<br>1024x768 1x18B<br>1280x768 1x18B<br>1400x1050 2x18B<br>1600x1200 2x18B<br>1280x800 1x18B<br>800x480 1x18B<br>1024x768 2x18B<br>1024x768 1x24B<br>1024x768 2x24B<br>1280x768 1x24B<br>1280x1024 2x24B<br>1400x1050 2x24B<br>1600x1200 2x24B | Select Panel Resolution that will be displayed depending on the LCD Panel (LFP)  |



### 3.5.3.3 CPU & PCI Bus Control

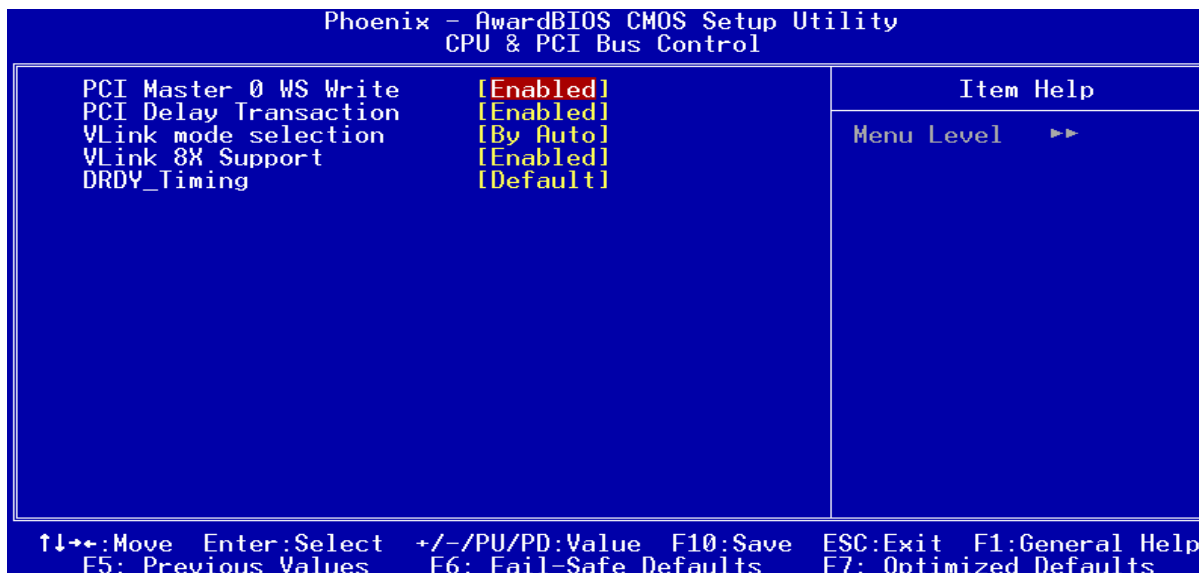

| Item                  | Options   | Description   |
|-----------------------|---|---|
| PCI Master 0 WS Write | Enabled<br>Disabled                                       | To write PCI bus while zero wait state is executed.   |
| PCI Delay Transaction | Enabled<br>Disabled                                       | This feature is used to meet the latency of PCI cycles to and from the ISA bus. The ISA bus is much, much slower than the PCI bus. Thus, PCI cycles to and from the ISA bus take a longer time to complete and this slows the PCI bus down.<br>However, enabling <b>PCI Delayed Transaction</b> enables the chipset's embedded 32-bit posted write buffer to support delayed transaction cycles. This means that transactions to and from the ISA bus are buffered and the PCI bus can be freed to perform other transactions while the ISA transaction is underway.<br>This option should be <b>enabled</b> for better performance and to meet PCI 2.1 specifications. "Disabled" is set only if the PCI cards cannot work properly or if an ISA card that is not PCI 2.1 compliant is used. |
| VLink Mode Selection  | By Auto<br>Mode 0<br>Mode 1<br>Mode 2<br>Mode 3<br>Mode 4 | The North Bridge interface to the South Bridge through a high speed(up to 1GB/Sec)8x, 66MHz Data Transfer interconnect bus caller "V-Link". This item allows you to select the V-Link mode from 0 to 4.   |
| VLink 8X Support      | Enabled<br>Disabled                                       | The feature is to toggle the V-Link bus mode between the original V-Link and the newer and faster 8X V-Link.  |
| DRDY_Timing           | Slowest<br>Default<br>Optimize                            | Allows to set the timing for each cycle that data is transferred.   |

### 3.5.3.4 Memory Hole

You can reserve this area of system memory for ISA adapter ROM. When this area is reserved it cannot be cached. The user information of peripherals that need to use this area of system memory usually2 discussed their memory requirements.

The choices: Disabled, 15M-16M.

## ECM-CX700

### 3.5.3.5 System BIOS Cacheable

This feature is only valid when the system BIOS is shadowed. It enables or disables the caching of the system BIOS ROM at **F0000h-FFFFFh** via the L2 cache. This greatly speeds up accesses to the system BIOS. However, this does **not** translate into better system performance because the OS does not need to access the system BIOS much.

| Item     | Description   |
|----------|---------------|
| Enabled  | Cacheable     |
| Disabled | Non-Cacheable |

### 3.5.3.6 Video RAM Cacheable

It enables or disables the caching of the video RAM at **A0000h-AFFFFh**. This greatly speeds up the video performance.

| Item     | Description   |
|----------|---------------|
| Enabled  | Cacheable     |
| Disabled | Non-Cacheable |

### 3.5.3.7 Init Display First

This item allows you to decide to active whether PCI Slot or Onboard/AGP first.

The choices: PCI Slot, AGP.

### 3.5.4 Integrated Peripherals

Use this menu to specify your settings for integrated peripherals.

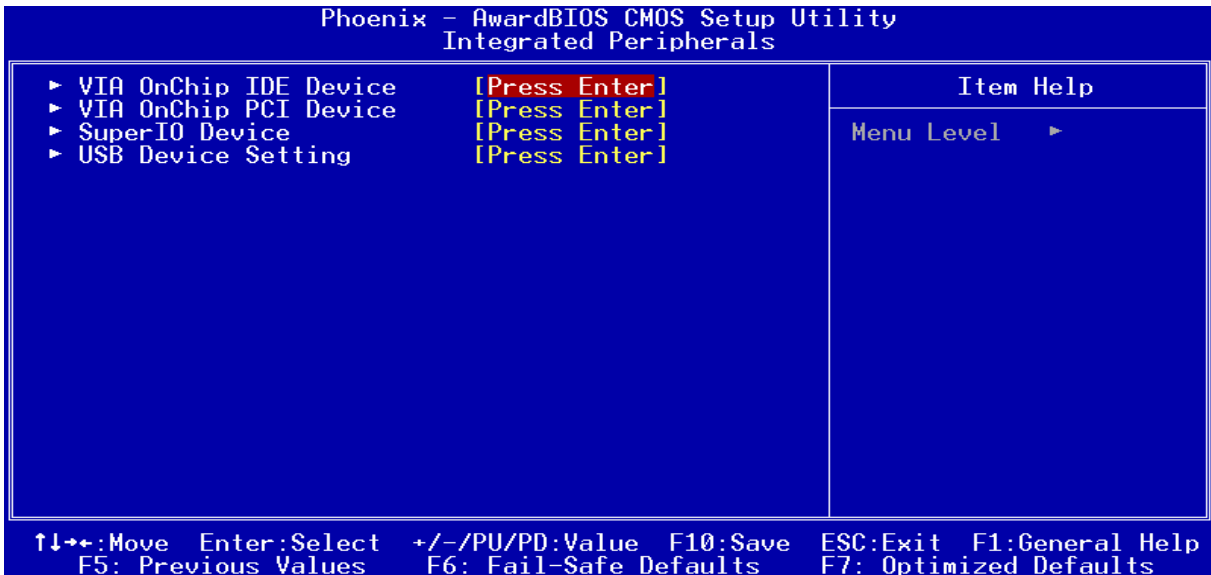

#### 3.5.4.1 VIA OnChip IDE Device

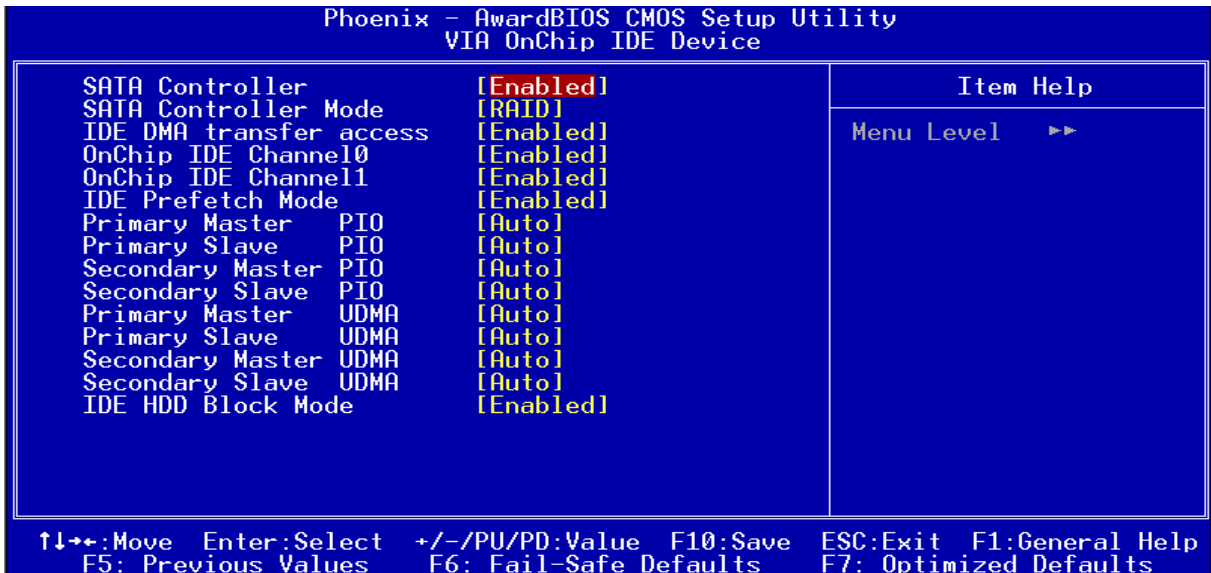

## ECM-CX700

| Item   | Options                                      | Description  |
|--|--|--|
| OnChip SATA  | Enabled<br>Disabled                          | The chipset contains a SATA IDE interface with support for two IDE channels. Select Enabled to activate the primary IDE interface (Channel0). Select Disabled to deactivate this interface.  |
| SATA Mode  | IDE<br>RAID<br>AHCI                          | Setup the onboard SATA Mode.   |
| IDE DMA Transfer Access  | Enabled<br>Disabled                          | This BIOS feature allows you to enable or disable DMA (Direct Memory Access) support for all IDE devices   |
| OnChip IDE Channel10/11  | Enabled<br>Disabled                          | The chipset contains a PCI IDE interface with support for two IDE channels. Select Enabled to activate the primary / secondary IDE interface (Channel 10/11). Select Disabled to deactivate this interface.  |
| IDE Prefetch Mode  | Enabled<br>Disabled                          | For faster drive accesses. If you install a primary and/or secondary add-in IDE interface, set this field to Disabled if the interface does not support prefetching.   |
| Primary Master PIO<br>Primary Slave PIO<br>Secondary Master PIO<br>Secondary Slave PIO     | Auto<br>Mode 1<br>Mode 2<br>Mode 3<br>Mode 4 | The IDE PIO (Programmed Input/Output) fields let you set a PIO mode (0-4) for each of the four IDE devices that the onboard IDE interface supports. Modes 0 through 4 provide successively increased performance. In Auto mode, the system automatically determines the best mode for each device. |
| Primary Master UDMA<br>Primary Slave UDMA<br>Secondary Master UDMA<br>Secondary Slave UDMA | Auto<br>Disabled                             | Ultra DMA implementation is possible only if your IDE hard drive supports it and the operating environment includes a DMA driver (Windows 95 OSR2 or a third-party IDE bus master driver). If the hard drive and the system software both support Ultra DMA, select Auto to enable BIOS support.   |
| IDE HDD Block Mode   | Enabled<br>Disabled                          | Block mode is also called block transfer, multiple commands, or multiple sector read/write. If the IDE hard drive supports block mode (most new drives do), select Enabled for automatic detection of the optimal number of block read/writes per sector the drive can support.                    |

### 3.5.4.2 VIA OnChip PCI Device

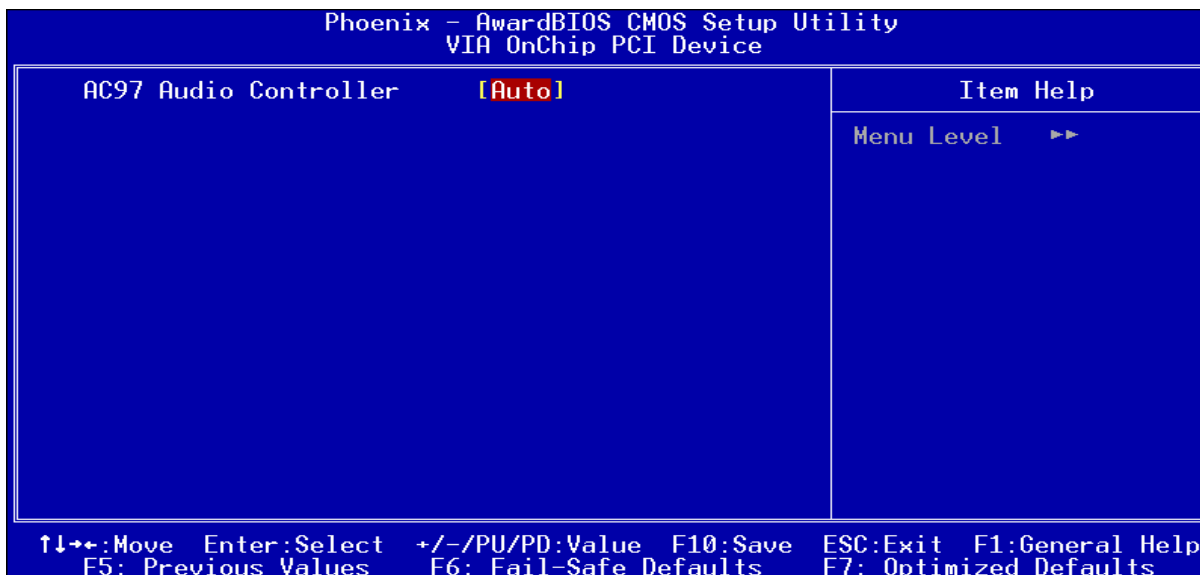

| Item             | Options          | Description  |
|------------------|------------------|--|
| AC97 Audio Codec | Auto<br>Disabled | This item allows you to decide to enable/disable the VIA chipset family to support AC97 Audio. |

### 3.5.4.3 Super IO Device

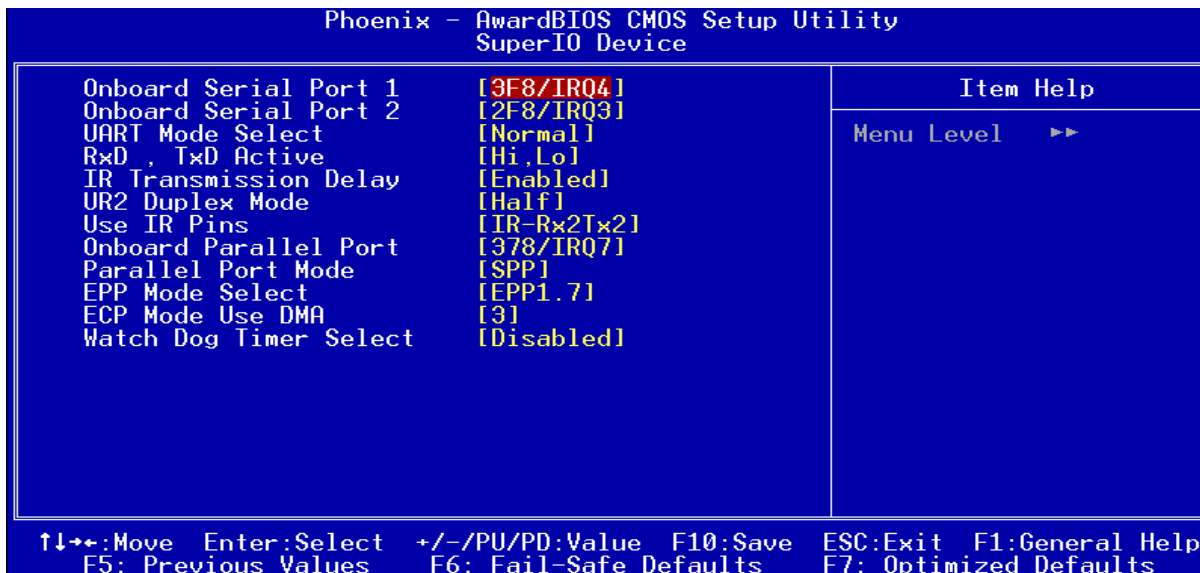

## ECM-CX700

| Item   | Options   | Description   |
|--|---|---|
| Onboard Serial Port 1<br>Onboard Serial Port 2 | Disable<br>3F8/IRQ4<br>2F8/IRQ3<br>3E8/IRQ4<br>2E8/IRQ3<br>AUTO | Select an address and corresponding interrupt for the first and second serial ports.  |
| UART Mode Select                               | IrDA<br>ASKIR<br>Normal   | This item allows you to determine which Infrared (IR) function of onboard I/O chip.   |
| RxD, TxD Active                                | Hi,Hi, Hi,Lo<br>Lo,Hi, Lo,Lo                                    | The item determines the active of RxD, TxD.   |
| IR Transmission Delay:                         | Enabled<br>Disabled   | The field enables or disables IR transmission delay function.   |
| UR2 Duplex Mode                                | Full<br>Half  | Select the value required by the IR device connected to the IR port. Full-duplex mode permits simultaneous two-direction transmission. Half-duplex mode permits transmission in one direction only at a time. |
| Use IR Pins                                    | RxD2,TxD2<br>IR-Rx2Tx2  | Select the correct setting of TxD and RxD signals.  |
| Onboard Parallel Port                          | Disabled<br>378/IRQ7<br>278/IRQ5<br>3BC/IRQ7                    | Select a matching address and interrupt for the physical parallel (printer) port.   |
| Parallel Port Mode                             | SPP<br>EPP<br>ECP<br>ECP+EPP<br>Normal                          | Select an operating mode for the onboard parallel port. Select Compatible or Extended unless you are certain both your hardware and software support EPP or ECP mode.   |
| EPP Mode Select                                | EPP1.9<br>EPP1.7  | Select EPP port type 1.7 or 1.9.  |
| ECP Mode Use DMA                               | 1<br>3  | Select a DMA channel for the port.  |
| Watch Dog Timer Select                         | Disabled<br>10, 20, 30, 40 Sec.<br>1, 2, 4 Min                  | This option will determine watch dog timer.   |

### 3.5.4.4 USB Device Setting

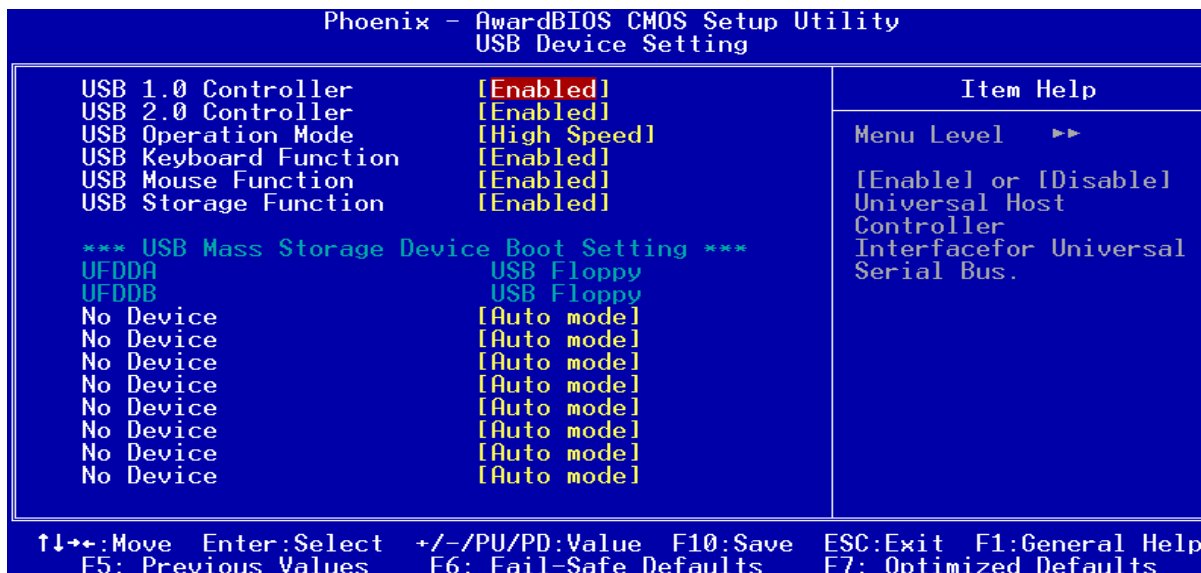

| Item                  | Options                      | Description   |
|-----------------------|------------------------------|---|
| USB 1.0 Controller    | Enabled<br>Disabled          | This item allows you to enable or disable the USB 1.0 support.      |
| USB 2.0 Controller    | Enabled<br>Disabled          | This item allows you to enable or disable the USB 2.0 support.      |
| USB Operation Mode    | Full/Low Speed<br>High Speed | This item allows you to select USB operation mode.                  |
| USB Keyboard Function | Enabled<br>Disabled          | This item allows you to enable or disable the USB keyboard support. |
| USB Mouse Function    | Enabled<br>Disabled          | This item allows you to enable or disable the USB mouse support.    |
| USB Storage Function  | Enabled<br>Disabled          | This item allows you to enable or disable the USB storage support.  |

## ECM-CX700

### 3.5.5 Power Management Setup

The Power Management Setup allows you to configure your system to most effectively save energy while operating in a manner consistent with your own style of computer use.

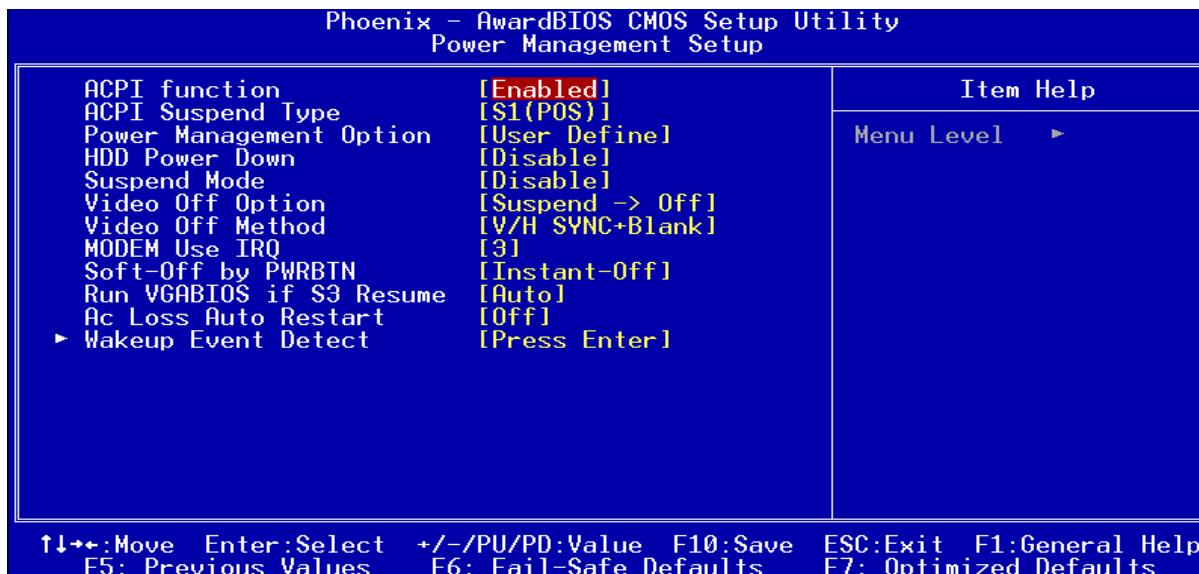

#### 3.5.5.1 ACPI Function

This item allows you to enable/disable the ACPI function.

The choices: Enable, Disable.

#### 3.5.5.2 ACPI Suspend Type

The item allows you to select the suspend type under the ACPI operating system.

The choices: S1(POS), S3(STR)

#### 3.5.5.3 Power Management Option

This category allows you to select the type (or degree) of power saving and is directly related to the following modes:

| Item              | Description   |
|-------------------|---|
| Min. Power Saving | Minimum power management, HDD Power Down = 15 Min,  |
| Max. Power Saving | Maximum power management, HDD Power Down = 1 Min,   |
| User Defined      | Allows you to set each mode individually. When not disabled, each of the ranges are from 1 min. to 1 hr. except for HDD Power Down which ranges from 1 min. to 15 min. and disable. |

#### 3.5.5.4 HDD Power Down

There are three selections for Power Management Option; both of them have fixed mode settings.

The choices: Disabled, 1, 2, 3, 4, 5, 6, 7, 8, 9, 10, 11, 12, 13, 14, 15 Min.



#### **3.5.5.5 Suspend Mode**

This setting defines the number of minutes before the system enters "suspend mode", the deepest level of system inactivity shutdown. The exact definition depends on the system, but in general this mode means that all system devices are shutdown (except for any that the BIOS is specifically told to keep running) and the processor is shut down to a trickle mode..

The choices: Disabled, 1, 2, 4, 6, 8, 10, 20, 30, 40 Min, 1 Hour.

#### **3.5.5.6 Video Off Option**

This determines the manner in which the monitor is always on or turned off during suspend mode.

The choices: Blank Screen, V/H SYNC+Blank, DPMS Support.

#### **3.5.5.7 MODEM Use IRQ**

This determines the IRQ in which the MODEM can use.

The choices: NA, 3, 4, 5, 7, 9, 10, 11.

#### **3.5.5.8 Soft-Off by PWRBTN**

Pressing the power button for more than 4 seconds forces the system to enter the Soft-Off state when the system has "hung".(Only could working on ATX Power supply)

The choices: Delay 4 Sec, Instant-Off.

#### **3.5.5.9 Run VGABIOS if S3 Resume**

Select whether to run VGA BIOS if resuming from S3 state. This is only necessary for older VGA drivers..

The choices: Auto, Yes, No.

#### **3.5.5.10 Ac Loss Auto Restart:**

This item is to set whether to run Ac Loss Auto Restart.

The choices: Off, On, Former-Sts.

3.5.5.11 Wakeup Event Detect

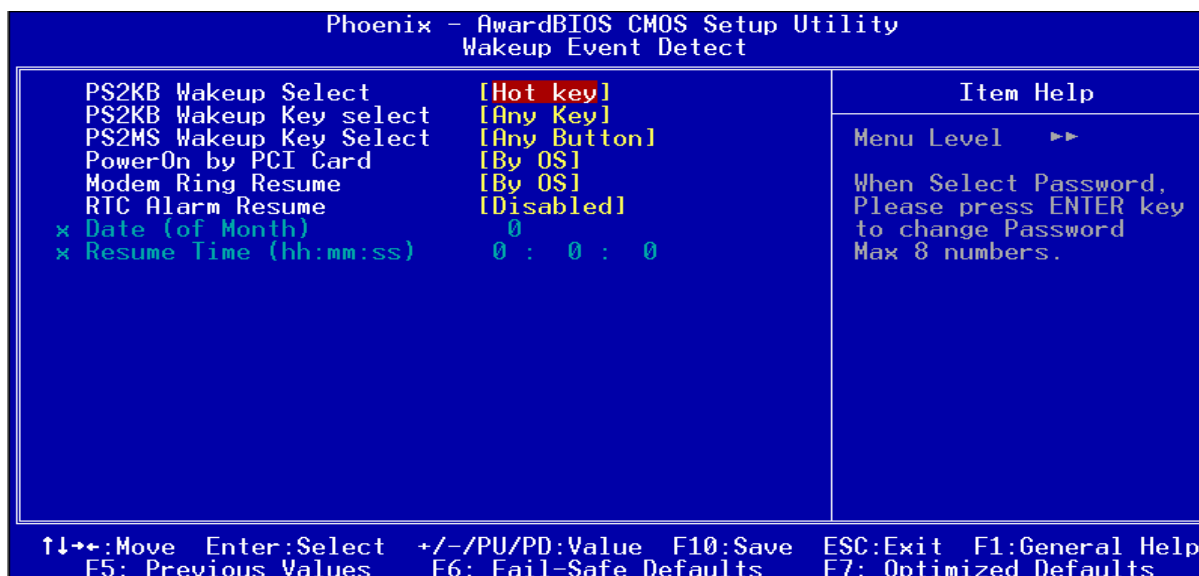

| Item                    | Options  | Description  |
|-------------------------|--|--|
| PS2KB Wakeup Select     | Hot Key<br>Password  | This item allows you to select Hot Key or Password to wake-up the system by PS2 Keyboard. When select Password, please press ENTER key to change password max 8 numbers. |
| PS2KB Wakeup Key Select | Ctrl+F1, Ctrl+F2<br>Ctrl+F3, Ctrl+F4<br>Ctrl+F5, Ctrl+F6<br>Ctrl+F7, Ctrl+F8<br>Ctrl+F9, Ctrl+F10<br>Ctrl+F11, Ctrl+F12<br>Disabled, Power Wake, Any Key | This item allows you to set a Hot Key to wake-up the system by PS2 Keyboard. Note: Power and Wake are Windows98 Keyboard button.   |
| PS2MS Wakeup Key Select | Any Button<br>Left Button<br>Right Button  | This item allows you to set a Hot Key to wake-up the system by PS2 mouse.  |
| PowerOn by PCI Card     | By OS<br>Enabled   | Enable activity detected from any PCI card to power up the system or resume from a suspended state.  |
| Modem Ring Resume       | BY OS<br>Enabled   | This item allows the modem ring to wake up the computer system from a power saving mode.   |
| RTC Alarm Resume        | Enabled<br>Disabled  | Sets a scheduled time and/or date to automatically power on the system.  |

### 3.5.6 PnP / PCI Configuration

This section describes configuring the PCI bus system. PCI, or **P**ersonal **C**omputer Interconnect, is a system which allows I/O devices to operate at speeds nearing the speed the CPU itself uses when communicating with its own special components. This section covers some very technical items and it is strongly recommended that only experienced users should make any changes to the default settings.

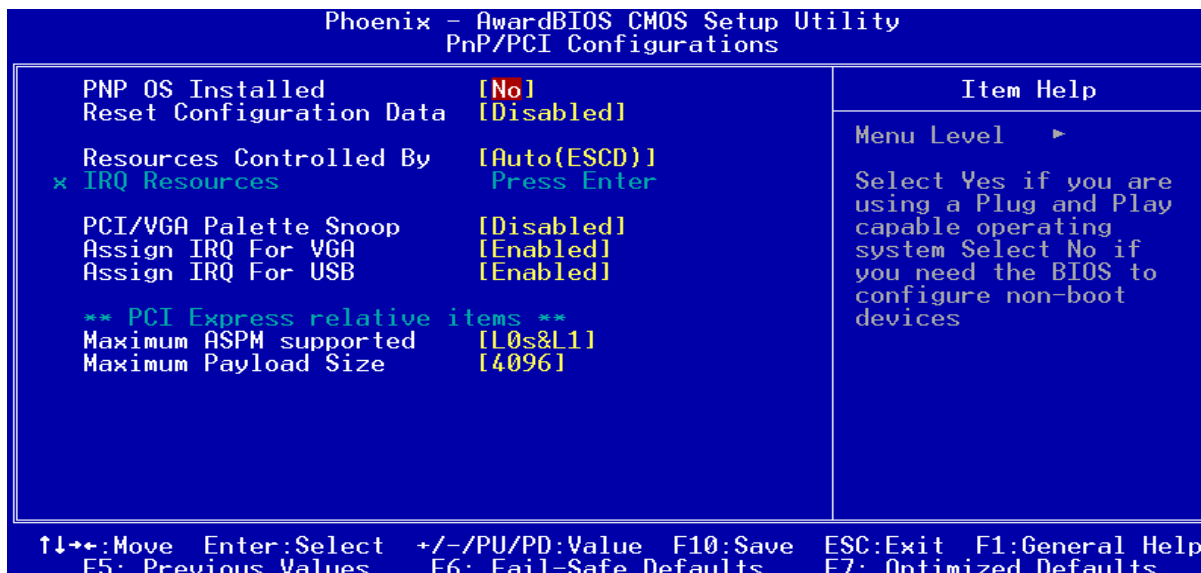

#### 3.5.6.1 PNP OS Installed

This item allows you to determine install PnP OS or not.

The choices: Yes, No.

#### 3.5.6.2 Reset Configuration Data

Normally, you leave this field Disabled. Select Enabled to reset Extended System Configuration Data (ESCD) when you exit Setup if you have installed a new add-on and the system reconfiguration has caused such a serious conflict that the operating system cannot boot.

The choices: Enabled, Disabled.

#### 3.5.6.3 Resources Controlled By

The Award Plug and Play BIOS has the capacity to automatically configure all of the boot and Plug and Play compatible devices. However, this capability means absolutely nothing unless you are using a Plug and Play operating system such as Windows®95. If you set this field to “manual” choose specific resources by going into each of the sub menu that follows this field (a sub menu is preceded by a “▶”).

The choices: Auto(ESCD), Manual.

## ECM-CX700

### 3.5.6.4 IRQ Resource

When resources are controlled manually, assign each system interrupt a type, depending on the type of device using the interrupt.

This item allows you to determine the IRQ assigned to the ISA bus and is not available to any PCI slot. Legacy ISA for devices compliant with the original PC AT bus specification, PCI/ISA PnP for devices compliant with the Plug and Play standard whether designed for PCI or ISA bus architecture.

The Choices: Legacy ISA, PCI/ISA PnP.

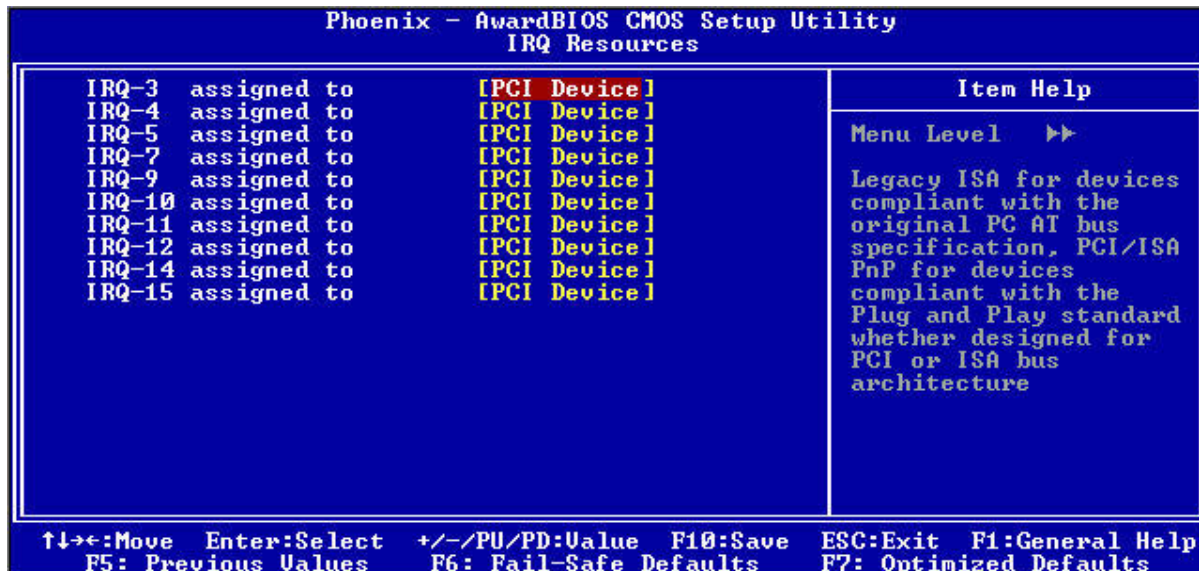

### 3.5.6.5 PCI / VGA Palette Snoop

Leave this field at Disabled.

The choices: Enabled, Disabled.

### 3.5.6.6 Assign IRQ For VGA

While the system has one VGA controller and more than one VGA devices are connected, then "Enabled" is set. If the system VGA controller is not used, then "Disabled" is set.

The choices: Enabled, Disabled.

### 3.5.6.7 Assign IRQ For USB

While the system has one USB controller and more than one USB devices are connected, then "Enabled" is set. If the system USB controller is not used, then "Disabled" is set.

The choices: Enabled, Disabled.

### 3.5.6.8 Maximum ASPM Supported

This field is used to control the maximum level of supported ASPM on the given PCI Express link on the system

The choices: L0, L0s, L1, L0s&L1.

### 3.5.6.9 Maximum Payload Size

This field is used to select the maximum TLP payload size of the PCI Express devices. The unit is byte.

The choices: 128, 256, 512, 1024, 2048, 4096.

### 3.5.7 PC Health Status

This section shows the status of your CPU, Fan & System.

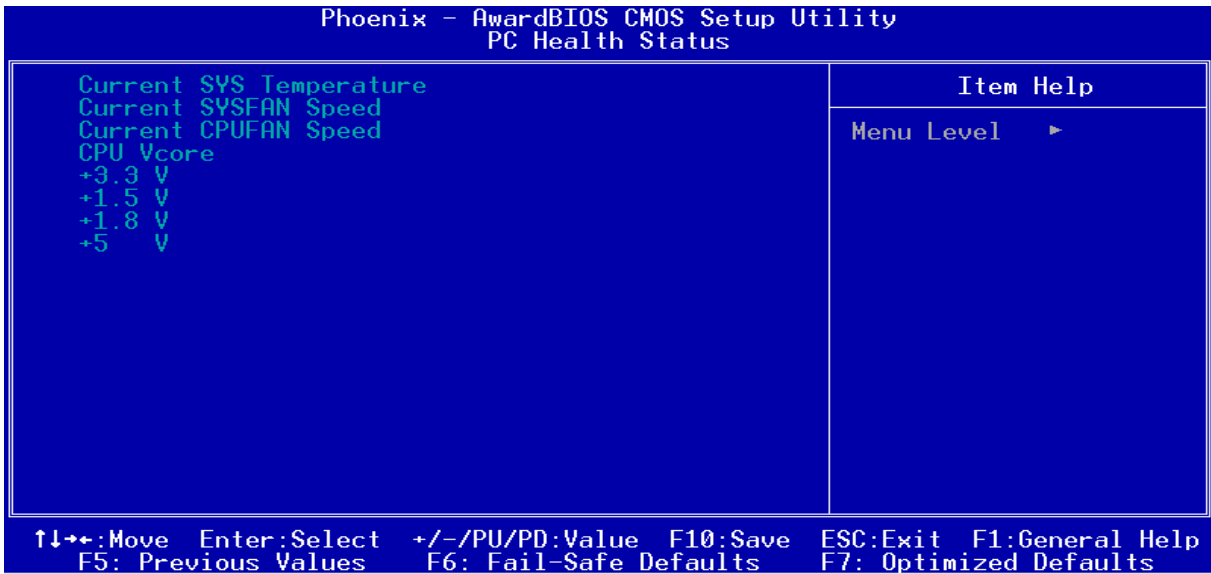

## ECM-CX700

### 3.5.8 Frequency / Voltage Control

This menu specifies your setting for frequency/voltage control.

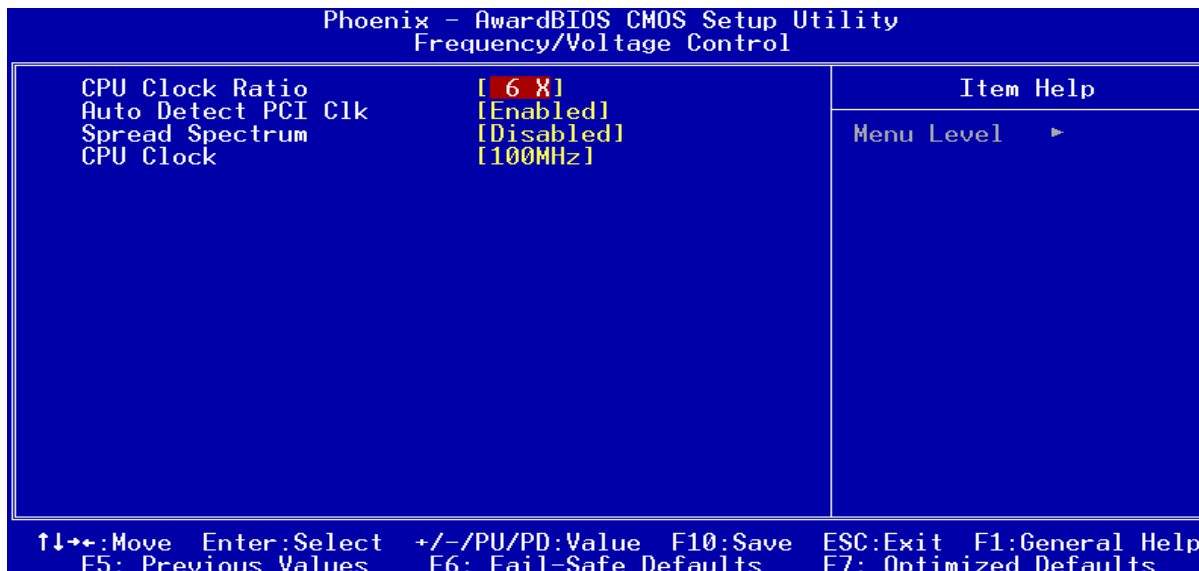

#### 3.5.8.1 Auto Detect PCI/SODIMM Clk:

This item allows you to enable/disable auto detect PCI/SODIMM Clock.

The choices: Enable, Disable.

#### 3.5.8.2 Spread Spectrum

This item is to adjust extreme values of the pulse for EMI test.

The choices: Enable, Disable.

### 3.5.9 Load Fail-Safe Defaults

Use this menu to load the BIOS default values for the minimal/stable performance for your system to operate.

Press <Y> to load the BIOS default values for the most stable, minimal-performance system operations.

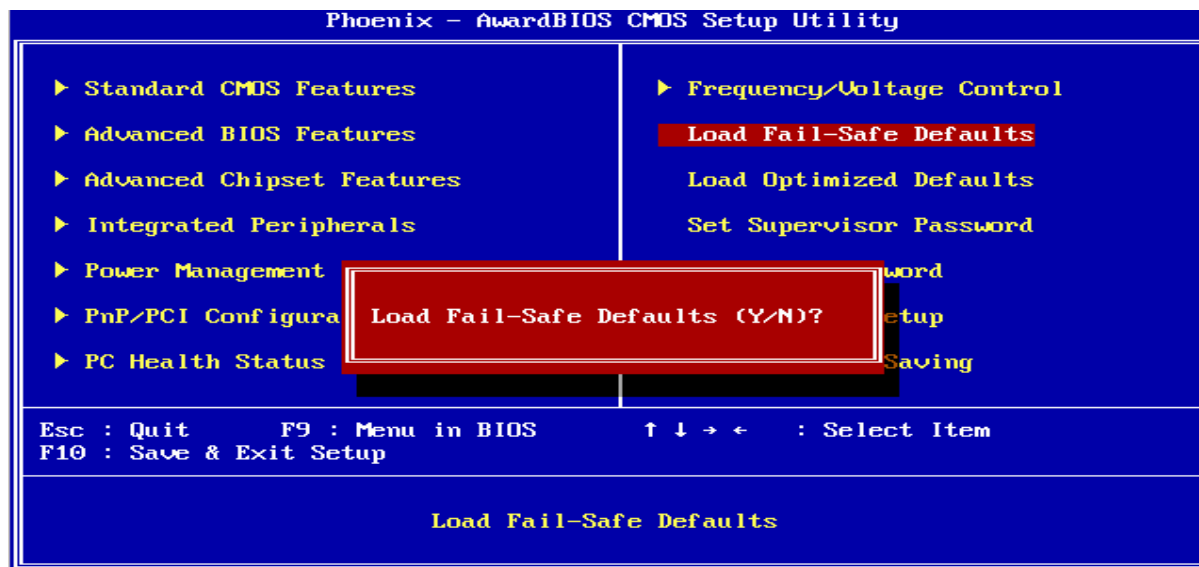

### 3.5.10 Load Optimized Defaults

Use this menu to load the BIOS default values that are factory settings for optimal performance system operations. While Award has designed the custom BIOS to maximize performance, the factory has the right to change these defaults to meet their needs. Press <Y> to load the default values setting for optimal performance system operations.

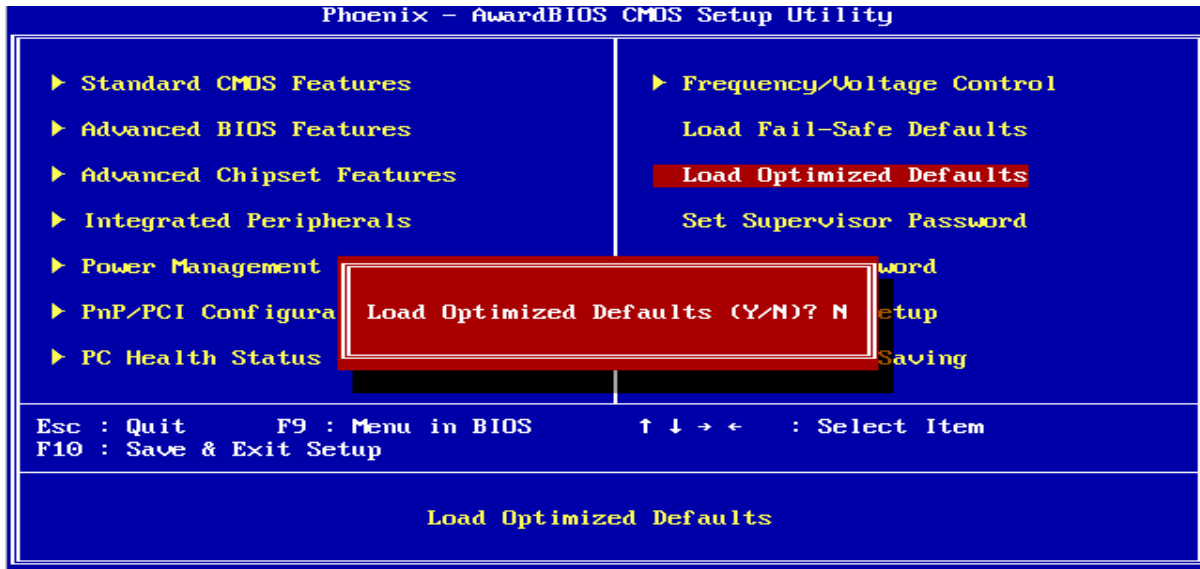

### 3.5.11 Set Supervisor / User Password

You can set either supervisor or user password, or both of them.

Supervisor Password: able to enter/change the options of setup menus.

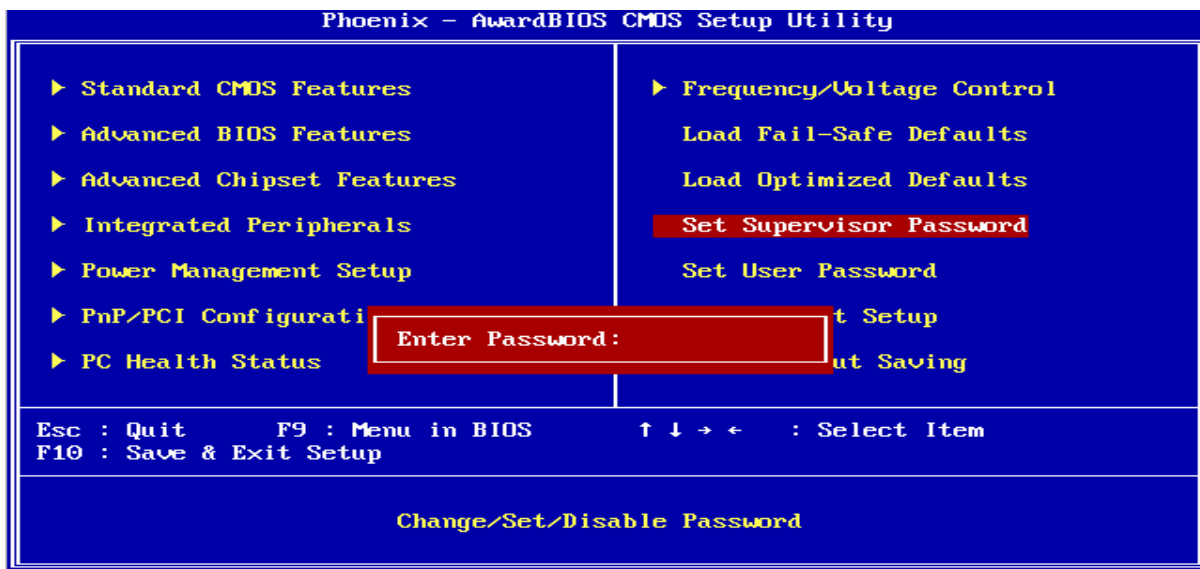

## ECM-CX700

User Password: able to enter but no right to change the options of setup menus.

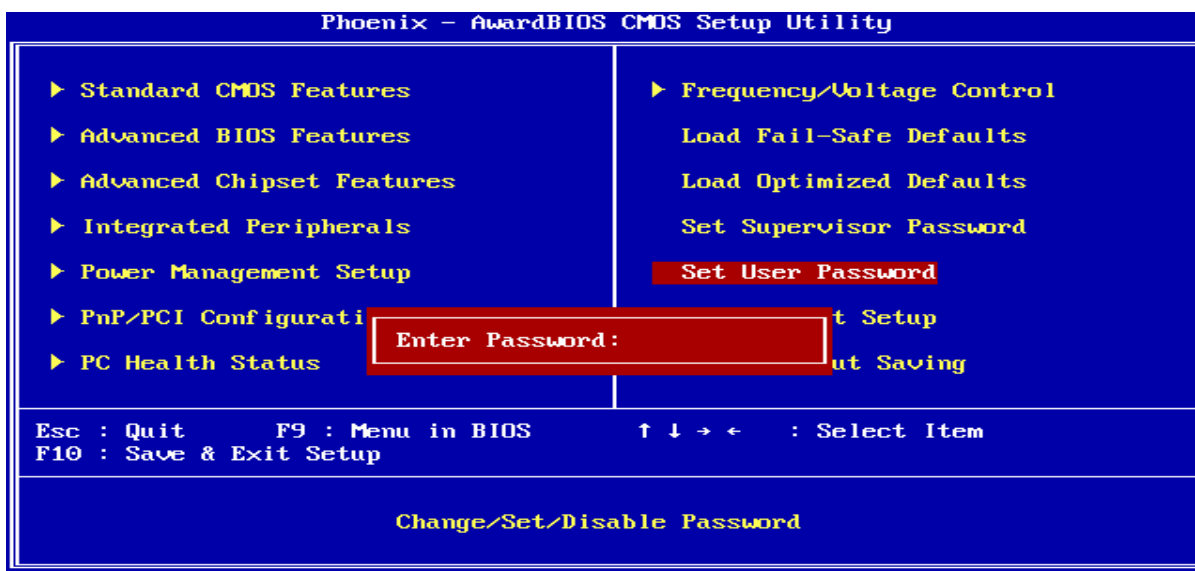

Type the password, up to eight characters in length, and press <Enter>. The password typed now will clear any previously entered password from CMOS memory. You will be asked to confirm the password. Type the password again and press <Enter>. You may also press <Esc> to abort the selection and not enter a password. To disable a password, just press <Enter> when you are prompted to enter the password. A message will confirm the password will be disabled. Once the password is disabled, the system will boot and you can enter Setup freely.

### PASSWORD DISABLED.

When a password has been enabled, you will be prompted to enter it every time you try to enter Setup. This prevents an unauthorized person from changing any part of your system configuration. Additionally, when a password is enabled, you can also require the BIOS to request a password every time your system is rebooted. This would prevent unauthorized use of your computer. You determine when the password is required within the BIOS Features Setup Menu and its Security option (see Section 3). If the Security option is set to “System”, the password will be required both at boot and at entry to Setup. If set to “Setup”, prompting only occurs when trying to enter Setup



### 3.5.12 Save & Exit Setup

Save CMOS value changes to CMOS and exit setup.

Enter <Y> to store the selection made in the menus in CMOS, a special section in memory that stays on after turning the system off. The BIOS configures the system according to the Setup selection stored in CMOS when boot the computer next time.

The system is restarted after saving the values.

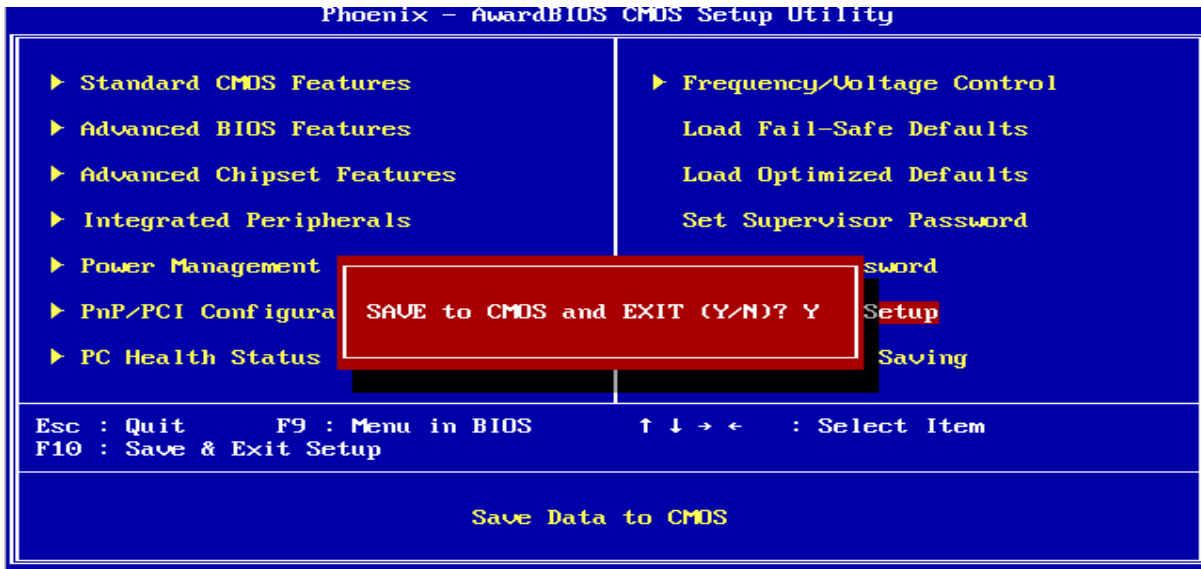

### 3.5.13 Exit Without Save

Abandon all CMOS value changes and exit setup, and the system is restarted after exiting.

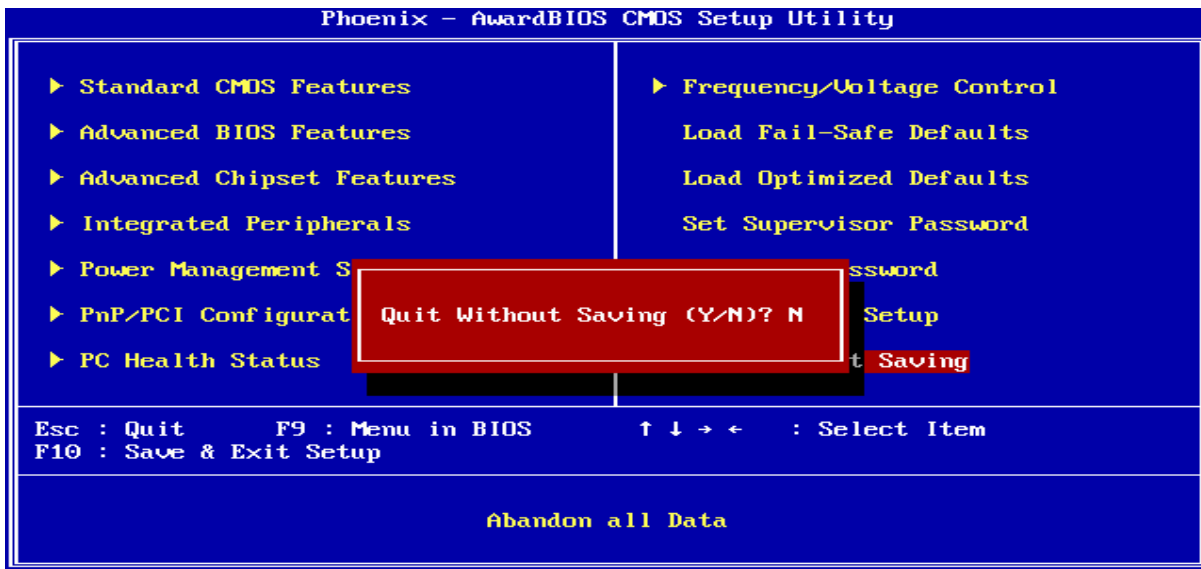

# 4. Drivers Installation

---



**Note:** Installation procedures and screen shots in this section are for your reference and may not be exactly the same as shown on your screen.

## 4.1 Install Chipset Driver (For VIA CX700M)

Insert the Supporting CD-ROM to CD-ROM drive, and it should show the index page of Avalue's products automatically. If not, locate Index.htm and choose the product from the menu left, or link to **\Driver\_Chipset\VIA\CX700**.



**Note:** The installation procedures and screen shots in this section are based on Windows XP operation system.

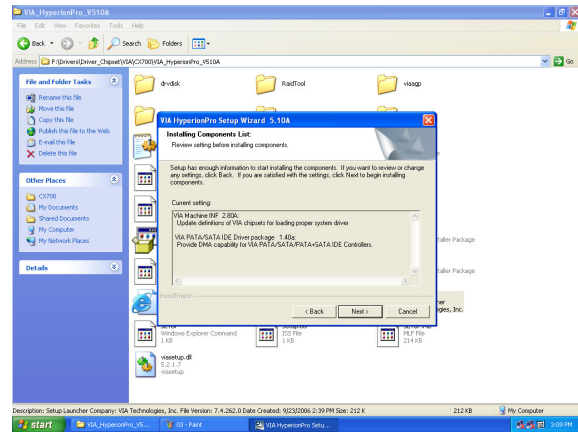

**Step 3.** Click **Next** to run the setup.

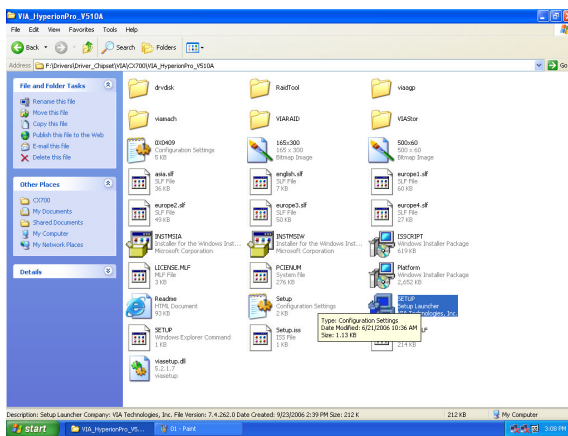

**Step 1.** Locate 「\Driver\_Chipset\VIA\CX700\ VIA\_HyperionPro\_V510A\setup.exe」.

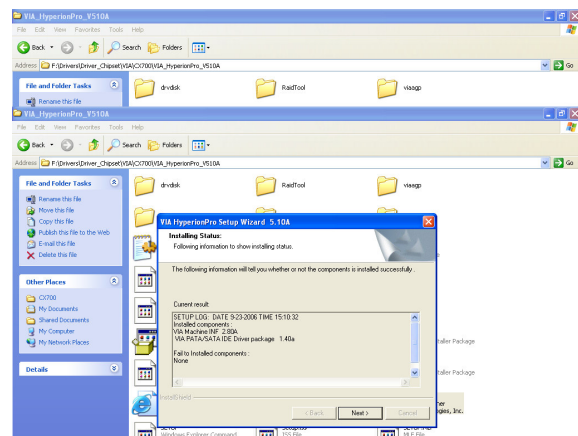

**Step 4.** Click **Next** to run another installation procedure.

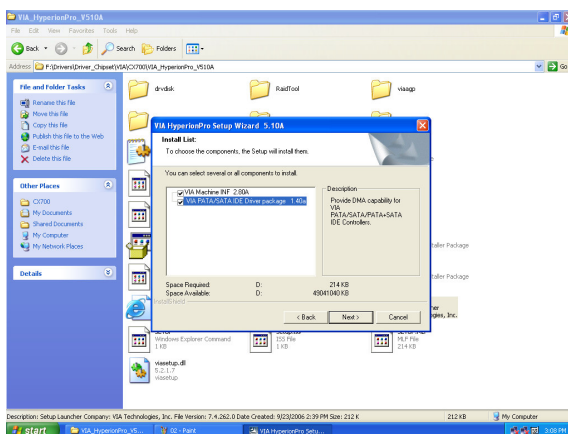

**Step 2.** Click **Next** to run the setup.

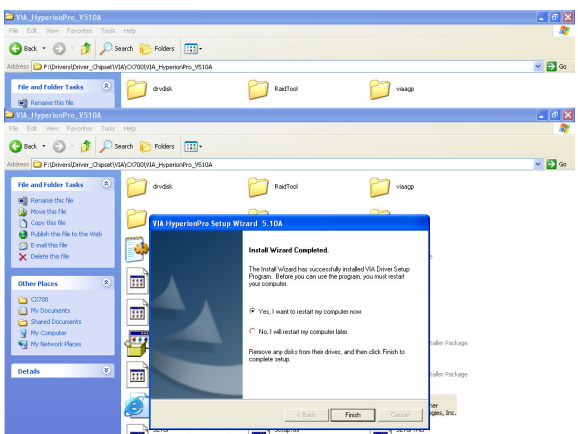

**Step 5.** Click **Finish** to restart the PC.

## 4.2 Install Display Driver (For VIA CX700)

Insert the Supporting CD-ROM to CD-ROM drive, and it should show the index page of Avalue's products automatically. If not, locate Index.htm and choose the product from the menu left, or link to

**\Driver\_Display\VIA\CX700.**



**Note:** The installation procedures and screen shots in this section are based on Windows XP operation system.

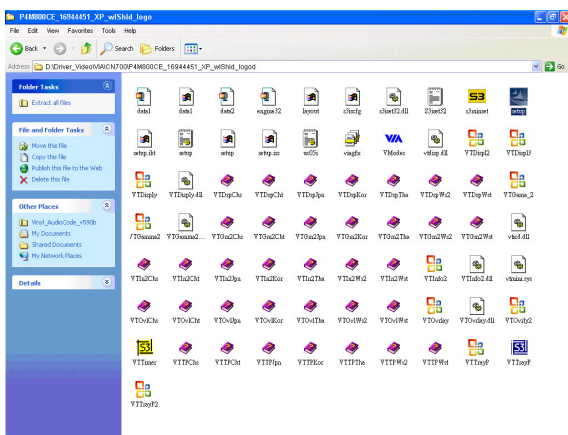

**Step1.** Locate 「\Driver\_Chipset\VIA\CX700\cx700\_xp\_16-94-44-64\_VGA\VT3324\_WinXP\_16-94-44-64\_wlShld\wlShld\Setup.exe」.

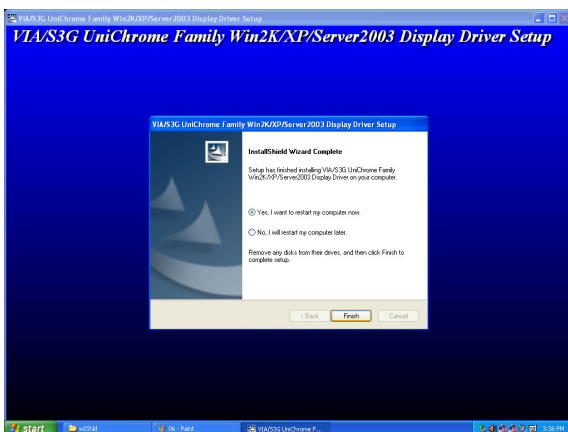

**Step 2.** Setup will run the installation automatically, then click **Finish** to restart the PC..

## 4.3 Install Audio Driver (For Realtek ALC883/ 7.1 CH with S/PDIF)

Insert the Supporting DVD-ROM to DVD-ROM drive, and it should show the index page of Avalue's products automatically. If not, locate Index.htm and choose the product from the menu left, or link to **\Driver\_Audio\Realtek\ALC883**.



**Note:** The installation procedures and screen shots in this section are based on Windows XP operation system.

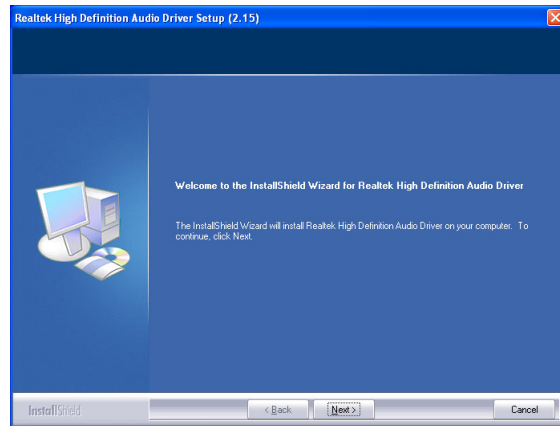

**Step 3.** Select **Next** to the next step.

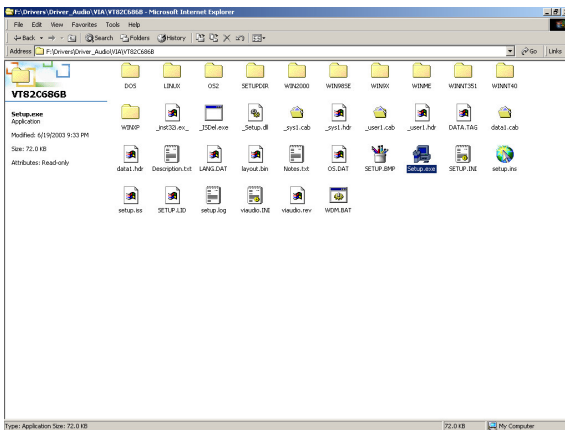

**Step 1.** Locate 「\Driver\_Audio\Realtek\ALC883\Windows XP\WDM\_R145\5288\_PG215\_R145\_UAAV10a-5013」.

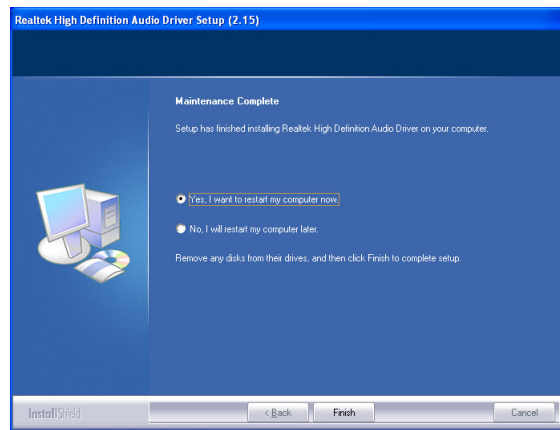

**Step 4.** Click **Finish** to complete the setup.

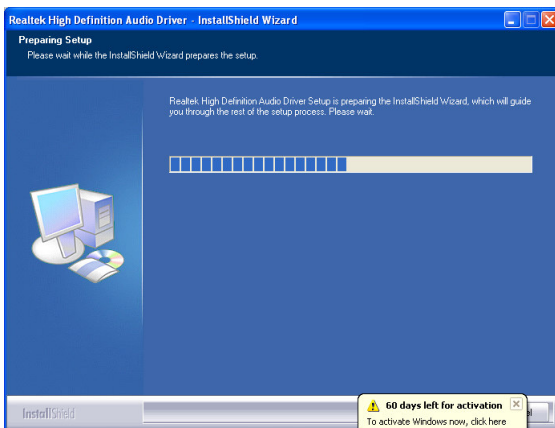

**Step 2.** The program executes the Setup automatically.

## 4.4 Install Audio Driver (For Realtek ALC883/ 5.1CH)

After the installation procedure by following **Section 4.3**, you need to go on this section in order to support 5.1 CH.



**Note:** The installation procedures and screen shots in this section are based on Windows XP operation system. **For 5.1 CH's supporting**, the function of MIC in and Line in will not workable. To enable Mic in and Line in, please DO NOT install 5.1 CH Audio driver.



**Step 3.** Launch the Audio setting interface and then You can enable 5.1CH by choosing 6CH Speaker from it.

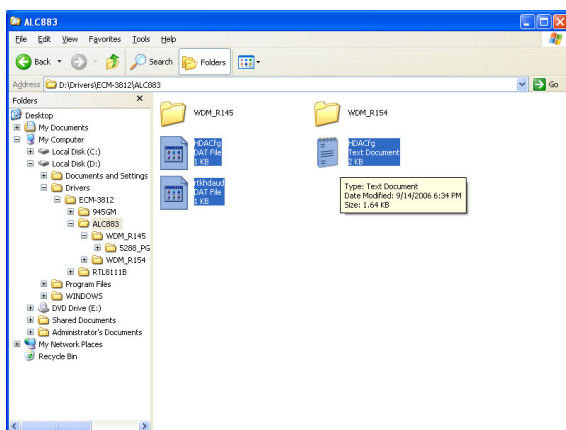

**Step 1.** Locate 「\Driver\_Audio\Realtek\ALC883\Windows XP\」 and copy 3 files: HDACfg.dat, HDACfg.txt, rtkhdaud.dat .

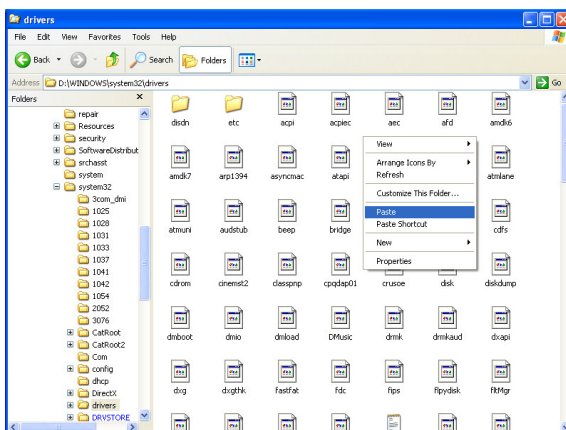

**Step 2.** Locate 「\WINDOWS\system32\drivers\」 and paste 3 files under this folder .

## 4.5 Install Ethernet Driver (For Realtek RTL8111B)

Insert the Supporting CD-ROM to CD-ROM drive, and it should show the index page of Avalue's products automatically. If not, locate Index.htm and choose the product from the menu left, or link to **D:\Driver\_Gigabit\Realtek\RTL8111B**.



**Note:** The installation procedures and screen shots in this section are based on Windows XP operation system.

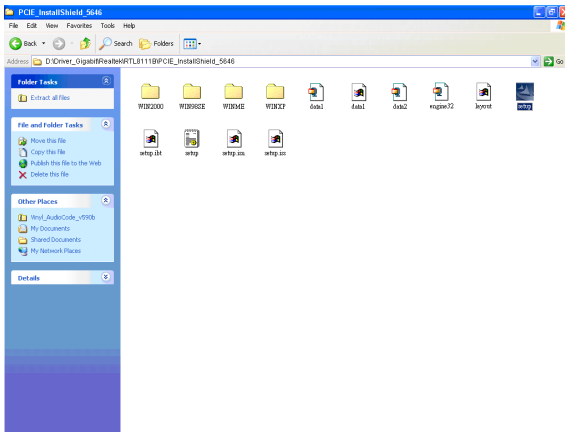

**Step 1.** Locate 「\Driver\_Gigabit\Realtek\RTL8111B\PCIE\_InstallShield\_5646\Setup.exe」.

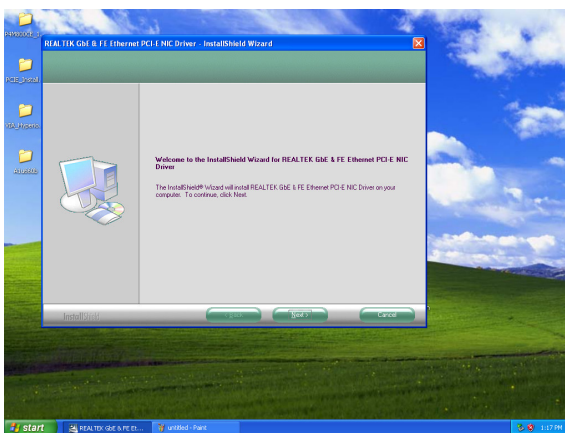

**Step 2.** Click **Next**.

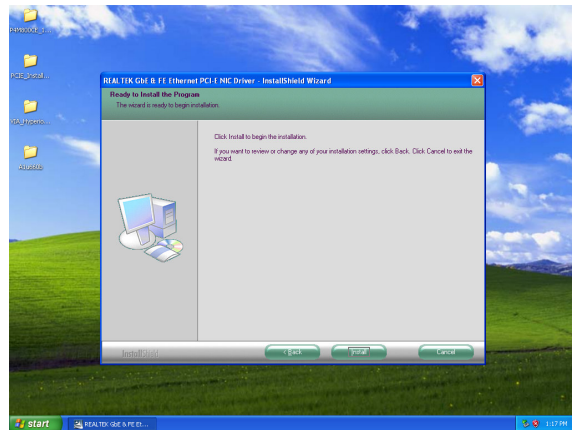

**Step 3.** Click **Next** to run the installation.

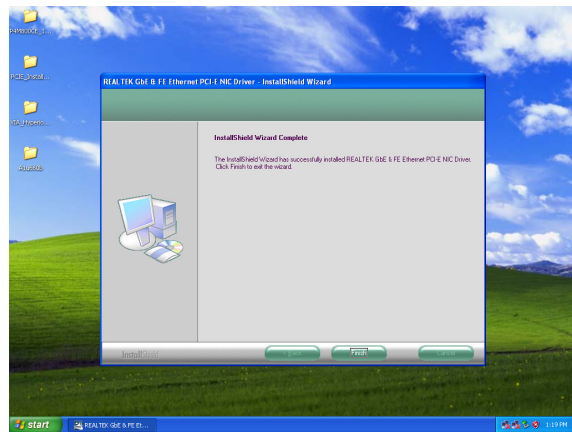

**Step 4.** Click **Finish** to complete the setup.

## 4.6 Install Touch Panel Driver (For PenMount DMC6000)

Insert the Supporting CD-ROM to CD-ROM drive, and it should show the index page of Avalue's products automatically. If not, locate Index.htm and choose the product from the menu left, or link to **\Driver\_TouchPanel\PenMount\DMC6000**.



**Note:** The installation procedures and screen shots in this section are based on Windows XP operation system.

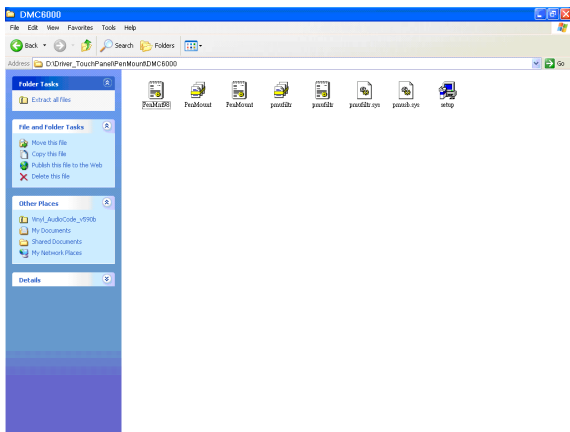

**Step 1.** Locate 「\Driver\_TouchPanel\PenMount\DMC6000\setup.exe」.

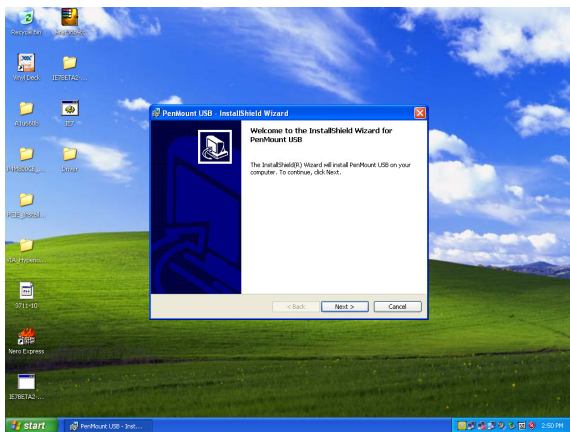

**Step 2.** Click Next.

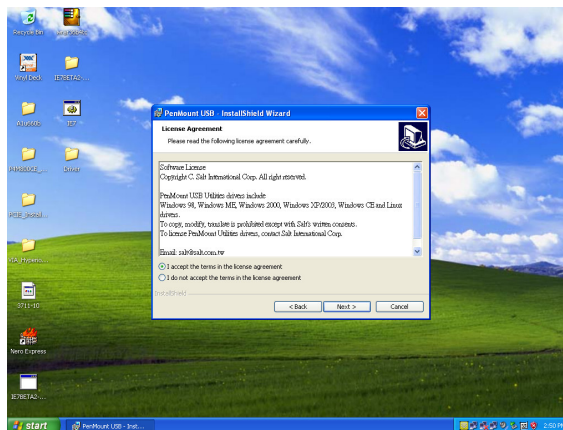

**Step 3.** Select **I Agree** and click **Next** to the following step.

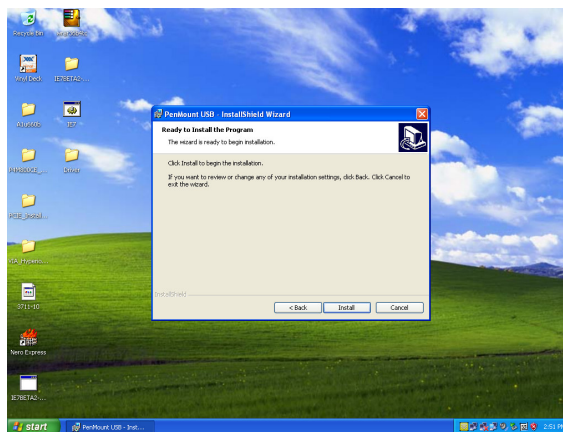

**Step 4.** Click **Install** to run the setup.

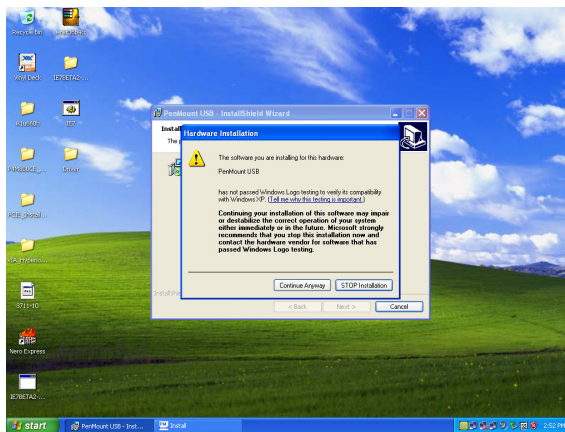

**Step 5.** Click **Continue Anyway**.



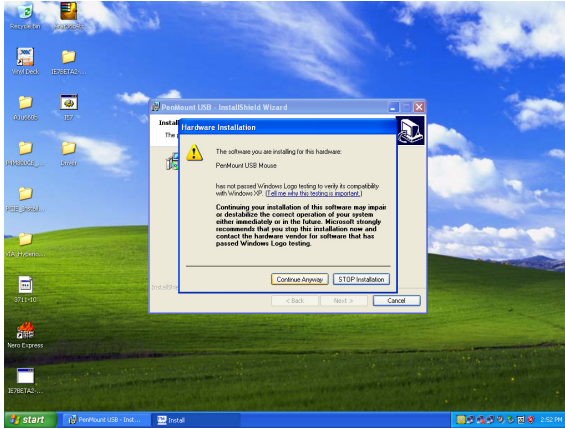

**Step 6.** Click **Continue Anyway** and the installation will complete automatically.

# 5. Mechanical Drawing

---



# Appendix A: BIOS Revisions

---

BIOS Rev.

New Features

Bugs/Problems Solved

Known Problems

# **Appendix B:**

# **AWARD BIOS POST**

# **Messages**

---

### Overview

During the Power On Self-Test (POST), if the BIOS detects an error requiring you to do something to fix, it will either sound a beep code or display a message.

If a message is displayed, it will be accompanied by:

PRESS F1 TO CONTINUE, CTRL-ALT-ESC OR DEL TO ENTER SETUP

### Post Beep

Currently there are two kinds of beep codes in BIOS. This code indicates that a video error has occurred and the BIOS cannot initialize the video screen to display any additional information. This beep code consists of a single long beep followed by two short beeps. The other code indicates that your DRAM error has occurred. This beep code consists of a single long beep repeatedly.

### Error Messages

One or more of the following messages may be displayed if the BIOS detects an error during the POST. This list includes messages for both the ISA and the EISA BIOS.

#### 1. CMOS BATTERY HAS FAILED

CMOS battery is no longer functional. It should be replaced.

#### 2. CMOS CHECKSUM ERROR

Checksum of CMOS is incorrect. This can indicate that CMOS has become corrupt. This error may have been caused by a weak battery. Check the battery and replace if necessary.

#### 3. DISK BOOT FAILURE, INSERT SYSTEM DISK AND PRESS ENTER

No boot device was found. This could mean that either a boot drive was not detected or the drive does not contain proper system boot files. Insert a system disk into Drive A: and press <Enter>. If you assumed the system would boot from the hard drive, make sure the controller is inserted correctly and all cables are properly attached. Also be sure the disk is formatted as a boot device. Then reboot the system.

#### 4. DISKETTE DRIVES OR TYPES MISMATCH ERROR - RUN SETUP

Type of diskette drive installed in the system is different from the CMOS definition. Run Setup to reconfigure the drive type correctly.

**5. DISPLAY SWITCH IS SET INCORRECTLY**

Display switch on the motherboard can be set to either monochrome or color. This indicates the switch is set to a different setting than indicated in Setup. Determine which setting is correct, and then either turn off the system and change the jumper, or enter Setup and change the VIDEO selection.

**6. DISPLAY TYPE HAS CHANGED SINCE LAST BOOT**

Since last powering off the system, the display adapter has been changed. You must configure the system for the new display type.

**7. EISA Configuration Checksum Error****PLEASE RUN EISA CONFIGURATION UTILITY**

The EISA non-volatile RAM checksum is incorrect or cannot correctly read the EISA slot. This can indicate either the EISA non-volatile memory has become corrupt or the slot has been configured incorrectly. Also be sure the card is installed firmly in the slot.

**8. EISA Configuration Is Not Complete****PLEASE RUN EISA CONFIGURATION UTILITY**

The slot configuration information stored in the EISA non-volatile memory is incomplete.



**Note:** When either of these errors appears, the system will boot in ISA mode, which allows you to run the EISA Configuration Utility.

**9. ERROR ENCOUNTERED INITIALIZING HARD DRIVE**

Hard drive cannot be initialized. Be sure the adapter is installed correctly and all cables are correctly and firmly attached. Also be sure the correct hard drive type is selected in Setup.

**10. ERROR INITIALIZING HARD DISK CONTROLLER**

Cannot initialize controller. Make sure the cord is correctly and firmly installed in the bus. Be sure the correct hard drive type is selected in Setup. Also check to see if any jumper needs to be set correctly on the hard drive.

**11. FLOPPY DISK CNTRLR ERROR OR NO CNTRLR PRESENT**

Cannot find or initialize the floppy drive controller. Make sure the controller is installed correctly and firmly. If there are no floppy drives installed, be sure the Diskette Drive selection in Setup is set to NONE.

## 12. Invalid EISA Configuration

### PLEASE RUN EISA CONFIGURATION UTILITY

The non-volatile memory containing EISA configuration information was programmed incorrectly or has become corrupt. Re-run EISA configuration utility to correctly program the memory.



**Note:** When either of these errors appears, the system will boot in ISA mode, which allows you to run the EISA Configuration Utility.

## 13. KEYBOARD ERROR OR NO KEYBOARD PRESENT

Cannot initialize the keyboard. Make sure the keyboard is attached correctly and no keys are being pressed during the boot.

If you are purposely configuring the system without a keyboard, set the error halt condition in Setup to HALT ON ALL, BUT KEYBOARD. This will cause the BIOS to ignore the missing keyboard and continue the boot.

## 14. Memory Address Error at ...

Indicates a memory address error at a specific location. You can use this location along with the memory map for your system to find and replace the bad memory chips.

## 15. Memory parity Error at ...

Indicates a memory parity error at a specific location. You can use this location along with the memory map for your system to find and replace the bad memory chips.

## 16. MEMORY SIZE HAS CHANGED SINCE LAST BOOT

Memory has been added or removed since the last boot. In EISA mode use Configuration Utility to reconfigure the memory configuration. In ISA mode enter Setup and enter the new memory size in the memory fields.

## 17. Memory Verify Error at ...

Indicates an error verifying a value already written to memory. Use the location along with your system's memory map to locate the bad chip.

## 18. OFFENDING ADDRESS NOT FOUND

This message is used in conjunction with the I/O CHANNEL CHECK and RAM PARITY ERROR messages when the segment that has caused the problem cannot be isolated.

## 19. OFFENDING SEGMENT:

This message is used in conjunction with the I/O CHANNEL CHECK and RAM PARITY ERROR messages when the segment that has caused the problem has been isolated.



**20. PRESS A KEY TO REBOOT**

This will be displayed at the bottom screen when an error occurs that requires you to reboot. Press any key and the system will reboot.

**21. PRESS F1 TO DISABLE NMI, F2 TO REBOOT**

When BIOS detects a Non-maskable Interrupt condition during boot, this will allow you to disable the NMI and continue to boot, or you can reboot the system with the NMI enabled.

**22. RAM PARITY ERROR - CHECKING FOR SEGMENT ...**

Indicates a parity error in Random Access Memory.

**23. Should Be Empty But EISA Board Found**

**PLEASE RUN EISA CONFIGURATION UTILITY**

A valid board ID was found in a slot that was configured as having no board ID.



**Note:** When either of these errors appears, the system will boot in ISA mode, which allows you to run the EISA Configuration Utility.

**24. Should Have EISA Board But Not Found**

**PLEASE RUN EISA CONFIGURATION UTILITY**

The board installed is not responding to the ID request, or no board ID has been found in the indicated slot.



**Note:** When either of these errors appears, the system will boot in ISA mode, which allows you to run the EISA Configuration Utility.

**25. Slot Not Empty**

Indicates that a slot designated as empty by the EISA Configuration Utility actually contains a board.



**Note:** When either of these errors appears, the system will boot in ISA mode, which allows you to run the EISA Configuration Utility.

**26. SYSTEM HALTED, (CTRL-ALT-DEL) TO REBOOT ...**

Indicates the present boot attempt has been aborted and the system must be rebooted. Press and hold down the CTRL and ALT keys and press DEL.

**27. Wrong Board In Slot**

**PLEASE RUN EISA CONFIGURATION UTILITY**

The board ID does not match the ID stored in the EISA non-volatile memory.



**Note:** When either of these errors appears, the system will boot in ISA mode, which allows you to run the EISA Configuration Utility.

**28. FLOPPY DISK(S) fail (80) → Unable to reset floppy subsystem.**

**29. FLOPPY DISK(S) fail (40) → Floppy Type mismatch.**

**30. Hard Disk(s) fail (80) → HDD reset failed.**

**31. Hard Disk(s) fail (40) → HDD controller diagnostics failed.**

**32. Hard Disk(s) fail (20) → HDD initialization error.**

**33. Hard Disk(s) fail (10) → Unable to recalibrate fixed disk.**

**34. Hard Disk(s) fail (08) → Sector Verify failed.**

**35. Keyboard is locked out - Unlock the key.**

BIOS detect the keyboard is locked. P17 of keyboard controller is pulled low.

**36. Keyboard error or no keyboard present.**

Cannot initialize the keyboard. Make sure the keyboard is attached correctly and no keys are being pressed during the boot.

**37. Manufacturing POST loop.**

System will repeat POST procedure infinitely while the P15 of keyboard controller is pull low. This is also used for M/B burn in test.

**38. BIOS ROM checksum error - System halted.**

The checksum of ROM address F0000H-FFFFFFH is bad.

**39. Memory test fail.**

BIOS reports the memory test fail if the onboard memory is tested error.

## 40. POST Codes

| POST (hex) | Description   |
|------------|---|
| CFh        | Test CMOS R/W functionality.  |
| C0h        | Early chipset initialization:<br>-Disable shadow RAM<br>-Disable L2 cache (socket 7 or below)<br>-Program basic chipset registers   |
| C1h        | Detect memory<br>-Auto-detection of DRAM size, type and ECC.<br>-Auto-detection of L2 cache (socket 7 or below)   |
| C3h        | Expand compressed BIOS code to DRAM   |
| C5h        | Call chipset hook to copy BIOS back to E000 & F000 shadow RAM.  |
| 0h1        | Expand the Xgroup codes locating in physical address 1000:0   |
| 02h        | Reserved  |
| 03h        | Initial Superio_Early_Init switch.  |
| 04h        | Reserved  |
| 05h        | 1. Blank out screen<br>2. Clear CMOS error flag   |
| 06h        | Reserved  |
| 07h        | 1. Clear 8042 interface<br>2. Initialize 8042 self-test   |
| 08h        | 1. Test special keyboard controller for Winbond 977 series Super I/O chips.<br>2. Enable keyboard interface.  |
| 09h        | Reserved  |
| 0Ah        | 1. Disable PS/2 mouse interface (optional).<br>2. Auto detect ports for keyboard & mouse followed by a port & interface swap (optional).<br>3. Reset keyboard for Winbond 977 series Super I/O chips. |
| 0Bh        | Reserved  |
| 0Ch        | Reserved  |
| 0Dh        | Reserved  |
| 0Eh        | Test F000h segment shadow to see whether it is R/W-able or not. If test fails, keep beeping the speaker.  |
| 0Fh        | Reserved  |
| 10h        | Auto detect flash type to load appropriate flash R/W codes into the run time area in F000 for ESCD & DMI support.   |
| 11h        | Reserved  |
| 12h        | Use walking 1's algorithm to check out interface in CMOS circuitry. Also set real-time clock power status, and then check for override.   |
| 13h        | Reserved  |
| 14h        | Program chipset default values into chipset. Chipset default values are MODBINable by OEM customers.  |

## ECM-CX700

| POST (hex) | Description  |
|------------|--|
| 15h        | Reserved   |
| 16h        | Initial Early_Init_Onboard_Generator switch.   |
| 17h        | Reserved   |
| 18h        | Detect CPU information including brand, SMI type (Cyrax or Intel) and CPU level (586 or 686).  |
| 19h        | Reserved   |
| 1Ah        | Reserved   |
| 1Bh        | Initial interrupts vector table. If no special specified, all H/W interrupts are directed to SPURIOUS_INT_HDLR & S/W interrupts to SPURIOUS_soft_HDLR.   |
| 1Ch        | Reserved   |
| 1Dh        | Initial EARLY_PM_INIT switch.  |
| 1Eh        | Reserved   |
| 1Fh        | Load keyboard matrix (notebook platform)   |
| 20h        | Reserved   |
| 21h        | HPM initialization (notebook platform)   |
| 22h        | Reserved   |
| 23h        | <ol style="list-style-type: none"><li>1. Check validity of RTC value:<br/>e.g. a value of 5Ah is an invalid value for RTC minute.</li><li>2. Load CMOS settings into BIOS stack. If CMOS checksum fails, use default value instead.</li><li>3. Prepare BIOS resource map for PCI &amp; PnP use. If ESCD is valid, take into consideration of the ESCD's legacy information.</li><li>4. Onboard clock generator initialization. Disable respective clock resource to empty PCI &amp; SODIMM slots.</li><li>5. Early PCI initialization:<ul style="list-style-type: none"><li>-Enumerate PCI bus number</li><li>-Assign memory &amp; I/O resource</li><li>-Search for a valid VGA device &amp; VGA BIOS, and put it into C000:0.</li></ul></li></ol> |
| 24h        | Reserved   |
| 25h        | Reserved   |
| 26h        | Reserved   |
| 27h        | Initialize INT 09 buffer   |
| 28h        | Reserved   |
| 29h        | <ol style="list-style-type: none"><li>1. Program CPU internal MTRR (P6 &amp; PII) for 0-640K memory address.</li><li>2. Initialize the APIC for Pentium class CPU.</li><li>3. Program early chipset according to CMOS setup. Example: onboard IDE controller.</li><li>4. Measure CPU speed.</li><li>5. Invoke video BIOS.</li></ol>  |
| 2Ah        | Reserved   |
| 2Bh        | Reserved   |
| 2Ch        | Reserved   |

| POST (hex) | Description  |
|------------|--|
| 2Dh        | 1. Initialize multi-language<br>1. Put information on screen display, including Award title, CPU type, CPU speed ....  |
| 2Eh        | Reserved   |
| 2Fh        | Reserved   |
| 30h        | Reserved   |
| 31h        | Reserved   |
| 32h        | Reserved   |
| 33h        | Reset keyboard except Winbond 977 series Super I/O chips.  |
| 34h        | Reserved   |
| 35h        | Reserved   |
| 36h        | Reserved   |
| 37h        | Reserved   |
| 38h        | Reserved   |
| 39h        | Reserved   |
| 3Ah        | Reserved   |
| 3Bh        | Reserved   |
| 3Ch        | Test 8254  |
| 3Dh        | Reserved   |
| 3Eh        | Test 8259 interrupt mask bits for channel 1.   |
| 3Fh        | Reserved   |
| 40h        | Test 8259 interrupt mask bits for channel 2.   |
| 41h        | Reserved   |
| 42h        | Reserved   |
| 43h        | Test 8259 functionality.   |
| 44h        | Reserved   |
| 45h        | Reserved   |
| 46h        | Reserved   |
| 47h        | Initialize EISA slot   |
| 48h        | Reserved   |
| 49h        | 1. Calculate total memory by testing the last double word of each 64K page.<br>2. Program writes allocation for AMD K5 CPU.  |
| 4Ah        | Reserved   |
| 4Bh        | Reserved   |
| 4Ch        | Reserved   |
| 4Dh        | Reserved   |
| 4Eh        | 1. Program MTRR of M1 CPU<br>2. Initialize L2 cache for P6 class CPU & program CPU with proper cacheable range.<br>3. Initialize the APIC for P6 class CPU.<br>4. On MP platform, adjust the cacheable range to smaller one in case the cacheable ranges between each CPU are not identical. |
| 4Fh        | Reserved   |
| 50h        | Initialize USB   |

## ECM-CX700

| POST (hex) | Description   |
|------------|---|
| 51h        | Reserved  |
| 52h        | Test all memory (clear all extended memory to 0)  |
| 53h        | Reserved  |
| 54h        | Reserved  |
| 55h        | Display number of processors (multi-processor platform)   |
| 56h        | Reserved  |
| 57h        | 1. Display PnP logo<br>2. Early ISA PnP initialization<br>-Assign CSN to every ISA PnP device.  |
| 58h        | Reserved  |
| 59h        | Initialize the combined Trend Anti-Virus code.  |
| 5Ah        | Reserved  |
| 5Bh        | (Optional Feature)<br>Show message for entering AWDFLASH.EXE from FDD (optional)  |
| 5Ch        | Reserved  |
| 5Dh        | 1. Initialize Init_Onboard_Super_IO switch.<br>2. Initialize Init_Onboard_AUDIO switch.   |
| 5Eh        | Reserved  |
| 5Fh        | Reserved  |
| 60h        | Okay to enter Setup utility; i.e. not until this POST stage can users enter the CMOS setup utility.   |
| 61h        | Reserved  |
| 62h        | Reserved  |
| 63h        | Reserved  |
| 64h        | Reserved  |
| 65h        | Initialize PS/2 Mouse   |
| 66h        | Reserved  |
| 67h        | Prepare memory size information for function call:<br>INT 15h ax=E820h  |
| 68h        | Reserved  |
| 69h        | Turn on L2 cache  |
| 6Ah        | Reserved  |
| 6Bh        | Program chipset registers according to items described in Setup & Auto-configuration table.   |
| 6Ch        | Reserved  |
| 6Dh        | 1. Assign resources to all ISA PnP devices.<br>2. Auto assign ports to onboard COM ports if the corresponding item in Setup is set to "AUTO". |
| 6Eh        | Reserved  |
| 6Fh        | 1. Initialize floppy controller<br>2. Set up floppy related fields in 40:hardware.  |
| 70h        | Reserved  |
| 71h        | Reserved  |
| 72h        | Reserved  |

| POST (hex) | Description  |
|------------|--|
| 73h        | (Optional Feature)<br>Enter AWDFLASH.EXE if :<br>-AWDFLASH is found in floppy drive.<br>-ALT+F2 is pressed   |
| 74h        | Reserved   |
| 75h        | Detect & install all IDE devices: HDD, LS120, ZIP, CDROM.....  |
| 76h        | Reserved   |
| 77h        | Detect serial ports & parallel ports.  |
| 78h        | Reserved   |
| 79h        | Reserved   |
| 7Ah        | Detect & install co-processor  |
| 7Bh        | Reserved   |
| 7Ch        | Reserved   |
| 7Dh        | Reserved   |
| 7Eh        | Reserved   |
| 7Fh        | 1. Switch back to text mode if full screen logo is supported.<br>-If errors occur, report errors & wait for keys<br>-If no errors occur or F1 key is pressed to continue:<br>♦Clear EPA or customization logo.   |
| 80h        | Reserved   |
| 81h        | Reserved   |
| 82h        | 1. Call chipset power management hook.<br>2. Recover the text font used by EPA logo (not for full screen logo)<br>3. If password is set, ask for password.   |
| 83h        | Save all data in stack back to CMOS  |
| 84h        | Initialize ISA PnP boot devices  |
| 85h        | 1. USB final Initialization<br>2. NET PC: Build SYSID structure<br>3. Switch screen back to text mode<br>4. Set up ACPI table at top of memory.<br>5. Invoke ISA adapter ROMs<br>6. Assign IRQs to PCI devices<br>7. Initialize APM<br>8. Clear noise of IRQs. |
| 86h        | Reserved   |
| 87h        | Reserved   |
| 88h        | Reserved   |
| 89h        | Reserved   |
| 90h        | Reserved   |
| 91h        | Reserved   |
| 92h        | Reserved   |
| 93h        | Read HDD boot sector information for Trend Anti-Virus code   |

**M-CX700**

| <b>POST (hex)</b> | <b>Description</b>   |
|-------------------|--|
| 94h               | <ol style="list-style-type: none"><li>1. Enable L2 cache</li><li>1. Program boot up speed</li><li>2. Chipset final initialization.</li><li>3. Power management final initialization</li><li>4. Clear screen &amp; display summary table</li><li>5. Program K6 write allocation</li><li>6. Program P6 class write combining</li></ol> |
| 95h               | <ol style="list-style-type: none"><li>1. Program daylight saving</li><li>1. Update keyboard LED &amp; typematic rate</li></ol>   |
| 96h               | <ol style="list-style-type: none"><li>1. Build MP table</li><li>2. Build &amp; update ESCD</li><li>3. Set CMOS century to 20h or 19h</li><li>4. Load CMOS time into DOS timer tick</li><li>5. Build MSIRQ routing table.</li></ol>   |
| FFh               | Boot attempt (INT 19h)   |