

**EN** - For pricing and availability in your local country please visit one of the below links:

**DE** - Informationen zu Preisen und Verfügbarkeit in Ihrem Land erhalten Sie über die unten aufgeführten Links:

**FR** - Pour connaître les tarifs et la disponibilité dans votre pays, cliquez sur l'un des liens suivants:

[FW7713/13 \( BLACK \)](#)

**EN**

This Datasheet is presented by  
the manufacturer

**DE**

Dieses Datenblatt wird vom  
Hersteller bereitgestellt

**FR**

Cette fiche technique est  
présentée par le fabricant



# Excellence In Power Solutions

Power Supplies



Datasheet.Live

Chargers



LED Drivers

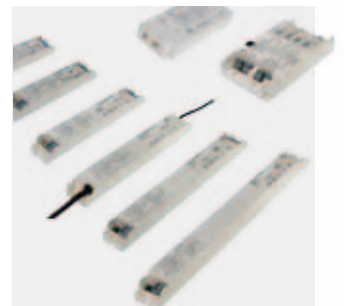

E<sup>2</sup>MS

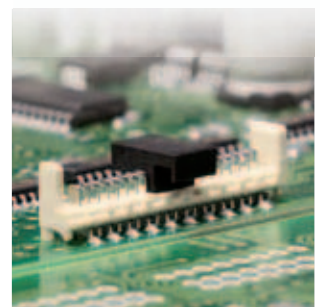

# Content

<b>FRIWO</b> .....	<b>4</b>
<b>Switchmode Power Supply Series</b>	
PP 3, PP 6, PP 8 .....	<b>6</b>
GPP 6, GPP 10, GPP 18, GPP 30 .....	<b>8</b>
MPP 6, MPP 15, MPP 30 .....	<b>10</b>
DT 12, DT 60, DT 100, DT 150 .....	<b>12</b>
<b>Medical Power Supply Series</b>	
GPP 6, GPP 10, GPP 18, GPP USB Medical .....	<b>14</b>
PP 8, MPP 15, MPP 30 .....	<b>16</b>
DT 12, DT 50, DT 80, DT 150 .....	<b>18</b>
<b>USB Series</b>	
GPP USB, PP USB, GUP, PP Mini USB .....	<b>20</b>
<b>CPP Series</b>	
PP 12, PP 18, PP 30 .....	<b>22</b>
<b>In-wall Power Supply Series</b>	
UP 6, UP 12, UP 18, UP USB .....	<b>24</b>
<b>Open Frame</b>	
OF 65, OF 100, OF 150 .....	<b>26</b>
OF 250, OF 450 .....	<b>28</b>
<b>Chargers</b>	
Li-Ion, LiFePO <sub>4</sub> .....	<b>30</b>
NiCd/NiMH, Pb .....	<b>32</b>
<b>Accessories</b>	
Primary/Secondary Adapter Plug System .....	<b>34</b>
Power Cords	
<b>LED Drivers</b>	
LT UP, LT 10, LT 20, LT 40, LT accessories .....	<b>36</b>
LT 40 WP, LT 40 SQ, LT 60, LT 60 SQ .....	<b>38</b>
LT 60 DPA, LT 100, DIMMbox, Light control .....	<b>40</b>
<b>E<sup>2</sup>MS</b> .....	<b>42</b>
<b>Glossary</b> .....	<b>44</b>
<b>Addresses</b> .....	<b>46</b>



# Innovative, efficient and competitive LED drivers, power supplies and chargers

## Competent R&D and manufacturing services for electronic modules

## Sustainable value for our customers, employees, owners, suppliers and partners

### Global Player

FRIWO operates worldwide as leading manufacturer of LED drivers, battery chargers and power supplies. FRIWO is the best resource for value-added electronics development and manufacturing. With our products and services we serve demanding clients in segments like electric mobility, power tools, high quality consumer equipment, medical, industrial automation, LED lighting and renewable energy.

We consider it a permanent challenge to keep up with current and future technologies. Customized products for contactless energy transfer have already been designed and are available for transmissions of up to 30 Watts.

### Power Supplies / Chargers

Since FRIWO has developed the world's first power supply, the name has become a trademark. FRIWO stands for technical competence in standard and customized solutions, from concept to finished product. In 1971 FRIWO has laid the foundation for constant market success and sets landmarks for power supply and charging technology, in accordance with current safety standards and regulations.

### Standards, Regulations and Responsibility

The stringent criteria and requirements of the various standards, are, of course, respected by FRIWO, many products remain even far below threshold limits.

FRIWO cooperates with leading test and inspection institutes, and the sophisticated development of the products allows worldwide approvals and marketing. All units are thoroughly tested for reliability in our own accredited test centers and leave our factory as „zero defect products“. FRIWO power supply and charging platforms are approved in Europe, the USA and Canada without any review. Laws and regulations regarding environmental responsibility and conservation of natural resources are becoming increasingly important. Based on the EU directive all FRIWO units meet the Electrical and Electronic Equipment Act – WEEE.



### FRIWO Highlights

- Global manufacturing in Europe and Asia
- Local Engineering
- High Quality
- Reliability / Long life cycle
- Robust, compact design
- Short development cycles
- Customized solutions
- Rapid Prototyping
- Certified according to
  - ISO 9001:2008
  - DIN EN ISO 14001:2009
  - TS16949

### Safety and Compliance

- RoHS, WEEE and REACH conform
- Reliability
  - Long term stability
  - Drop tests
  - X-Ray
  - 100% inspection
- Medical safety standard 3rd Edition EN60601-1, ES60601
- Expert knowledge and close relationships with approval agencies (SIQ, VDE, UL,...)

### Mechanical / Electrical Design

- PCB layout
- Short development cycles
  - EMI laboratory
  - 3D Printer
  - Prototyping
- Proprietary IC
  - Low Standby
  - High efficiency (Valley detection)
  - Universal operation mode
  - Optimized IU curve for constant current and constant voltage
  - Know-how – protection / copy protection
- Potting
  - Protection against harsh environmental conditions
  - IP67
  - Robustness
  - Shock resistance
- Peak current concepts
- Direct access to FRIWO engineers
- Lowest leakage currents (no Y-capacitor)





# Switchmode Power Supplies PP Series

All products conform to IEC 60950

### Applications

- Audio
- Bluetooth/WLAN
- Digital cameras
- Communication accessories
- Measurement and weighing technology
- MPEG Player
- Modems DSL, ADSL, VDSL
- PDA
- Safety technology

### Characteristics

- Universal input 100 to 240 V AC
- Constant voltage, current limited
- Low leakage current  $\leq 10 \mu\text{A}$
- Low standby power  $\leq 0.3 \text{ Watts}$
- Continuously short circuit proof

### Technical data

**Input voltage** 100 to 240 V AC ( $\pm 10\%$ )

**Input current** 90 mA (PP 3)  
150 mA (PP 6)  
200 mA (PP 8)

**Frequency** 50 to 60 Hz

**Efficiency** 75% typ. at full load

**EMC** Conforms to EN 55011, EN 55022/B, FCC 47 part 15, EN 61000-3-2, EN 61000-4-2, EN 61000-4-3, EN 61000-4-4, EN 61000-4-5, EN 61000-4-6, EN 61000-4-11

**Output voltage tolerance**  $\pm 2\%$  (without consideration of the output lead)

### Environmental specification

**Operating temperature** 0 to 40° C at maximum load

**Storage temperature** -20 to 70° C

**Humidity** 5% to 95% non condensing

**Input transient susceptibility** Complies with IEC 61000 requirements

### Safety specification

#### Standards

Fulfils class II, SELV according to following standards:  
IEC/EN/UL 60950

### Reliability specification

**MTBF calculation** 200.000 hours at maximum load and an ambient temperature of 25° C (in accordance with MIL-HDBK-217)

### Mechanical specification

#### Weight approx.

60 g (PP 3)  
105 g (PP 6)  
110 g (PP 8)

#### Plug connector

AC input:  
FRIWO exchangeable mains plug system:  
EURO, UK, USA/Japan\*  
DC output:  
Universal output plug system (page 34)

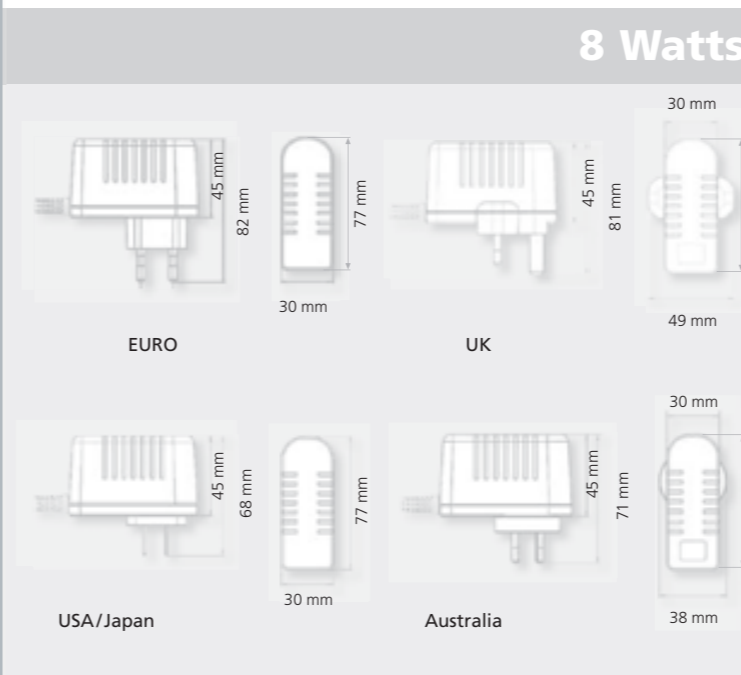
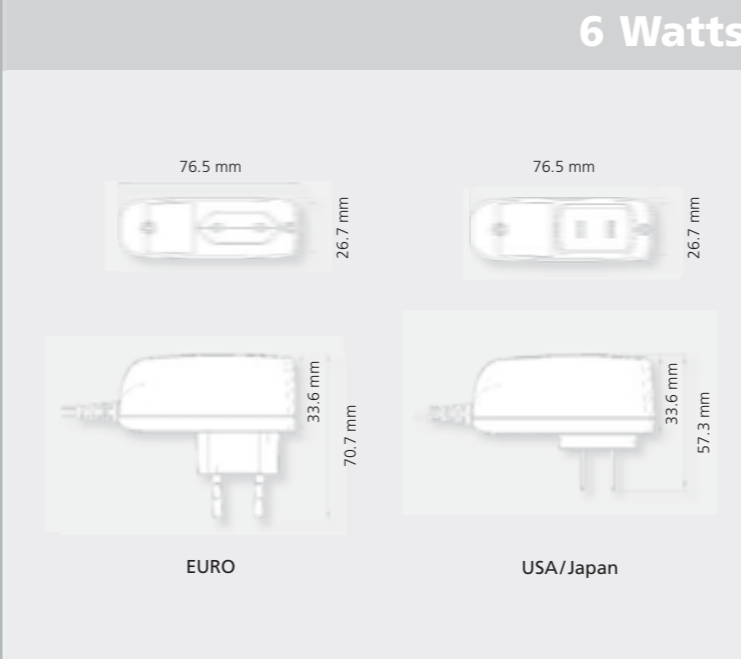
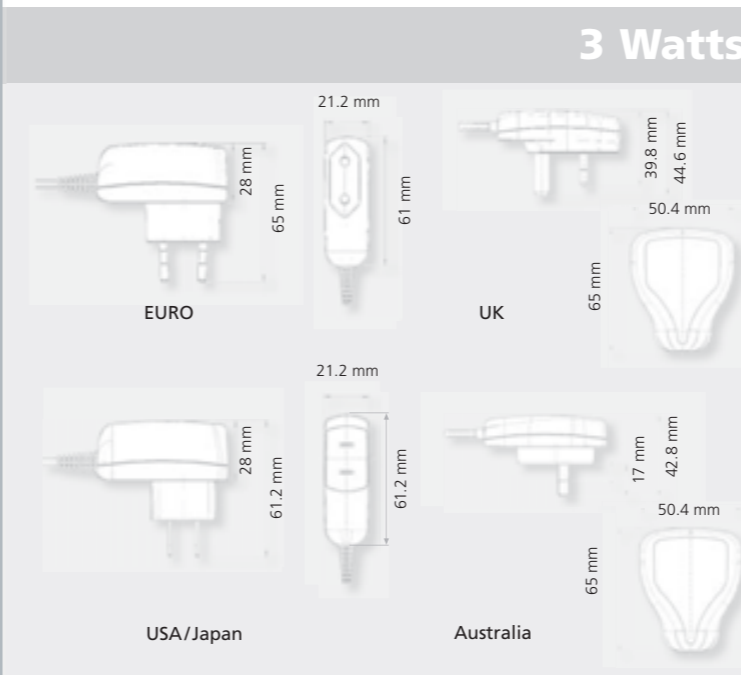

Output data		Ripple	EURO	USA/Japan	UK
Voltage	Current	Voltage	Order No.	Order No.	Order No.
5 V	650 mA	300 mV pp	1882750	1882760	1824460
6 V	550 mA	300 mV pp	1890574	1825734	1825733
7.5 V	450 mA	300 mV pp	1826282	1830703	1826268
9 V	360 mA	300 mV pp	1890562	1890576	1890575
12 V	270 mA	300 mV pp	1882753	1882763	1824461
15 V	220 mA	300 mV pp	1890714	1890716	1890715
24 V	135 mA	300 mV pp	1890717	1890718	1890719

Output data		Ripple	EURO	USA/Japan
Voltage	Current	Voltage	Order No.	Order No.
5 V	1000 mA	200 mV pp	1882105	1814934
6 V	850 mA	180 mV pp	1882106	1814935
7.5 V	650 mA	150 mV pp	1882107	1814936
9 V	550 mA	150 mV pp	1882108	1814937
12 V	450 mA	150 mV pp	1882109	1814938
15 V	360 mA	150 mV pp	1882110	1814939
18 V	300 mA	150 mV pp	1882111	1814940
24 V	220 mA	150 mV pp	1882112	1814941

Output data		Ripple	EURO	USA/Japan	UK
Voltage	Current	Voltage	Order No.	Order No.	Order No.
5 V	1300 mA	200 mV pp	1829491	1829580	1829562
6 V	1150 mA	180 mV pp	1829492	1829581	1829563
7.5 V	900 mA	150 mV pp	1829493	1829582	1829564
9 V	800 mA	150 mV pp	1829494	1829583	1829565
12 V	700 mA	150 mV pp	1829495	1829584	1829566
15 V	530 mA	150 mV pp	1829496	1829585	1829567
18 V	440 mA	150 mV pp	1829497	1829586	1829568
24 V	330 mA	150 mV pp	1829498	1829587	1829569

\* Australia version available for OEM quantities



# Switchmode Power Supplies GPP Series

with exchangeable primary adapters

All products conform to IEC 60950

## Applications

- Mobile applications
- Bluetooth
- Digital cameras
- Communication accessories
- Measurement and weighing technology
- Modems DSL, WLAN
- Elektronic cash systems
- Safety technology

## Characteristics

- Universal input 100 to 240 V AC
- Constant voltage, current limited
- Exchangeable primary adapters
- Low leakage current  $\leq 10 \mu\text{A}$  (GPP 6, GPP 10, GPP 18)
- Low standby power  $\leq 0.3$  Watts
- Continuously short circuit proof

## Technical data

**Input voltage** 100 to 240 V AC ( $\pm 10\%$ )  
**Input current** 150 mA (GPP 6), 250 mA (GPP 10), 400 mA (GPP 18), 600 mA (GPP 30)

**Frequency** 50 to 60 Hz  
**Efficiency** 80 % typ. at full load  
**EMC** Conforms to

EN 55011, EN 55022/B, FCC 47 part 15, EN 61000-3-2, EN 61000-4-2, EN 61000-4-3, EN 61000-4-4, EN 61000-4-5, EN 61000-4-6, EN 61000-4-11

**Output voltage tolerance**  $\pm 2\%$  (without consideration of the output lead)

## Environmental specification

**Operating temperature** 0 to 40° C at maximum load  
**Storage temperature** -40 to 70° C  
**Humidity** 5 % to 95 % non condensing  
**Input transient susceptibility** Complies with IEC 61000 requirements

## Safety specification

**Standards** Fulfils class II, SELV according to following standards: IEC/EN/UL 60950

## Reliability specification

**MTBF calculation** 200.000 hours at maximum load and an ambient temperature of 25° C (in accordance with MIL-HDBK-217)

## Mechanical specification

**Weight approx.** 80 g (GPP 6), 113 g (GPP 10), 170 g (GPP 18), 200 g (GPP 30)

**Plug connector** AC input: FRIWO exchangeable mains plug system: EURO, UK, USA/Japan, Australia, IEC DC output: Universal output plug system (page 34)

For primary adapters see page 34

**GPP 6** FW 7662

**6 Watts**

Output data			Worldwide
Voltage	Current	Ripple Voltage	Order No.
5 V	1100 mA	200 mV pp	1891660
5.9 V	1000 mA	200 mV pp	1891661
7.5 V	800 mA	200 mV pp	1891662
9 V	600 mA	200 mV pp	1891663
12 V	500 mA	200 mV pp	1891664
15 V	400 mA	200 mV pp	1891665
18 V	330 mA	200 mV pp	1891666
24 V	250 mA	200 mV pp	1891667

**GPP 10** FW 7660

**10 Watts**

Output data			Worldwide
Voltage	Current	Ripple Voltage	Order No.
5 V	1600 mA	75 mV pp	1827490
5.9 V	1400 mA	75 mV pp	1827491
9 V	1000 mA	75 mV pp	1827493
12 V	800 mA	75 mV pp	1827494
15 V	700 mA	75 mV pp	1827495
18 V	560 mA	125 mV pp	1827496
24 V	420 mA	125 mV pp	1827497

**GPP 18** FW 7556

**18 Watts**

Output data			Worldwide
Voltage	Current	Ripple Voltage	Order No.
5 V	3000 mA	75 mV pp	1828724
5.9 V	2500 mA	75 mV pp	1828725
9 V	1800 mA	90 mV pp	1828727
12 V	1500 mA	100 mV pp	1828728
15 V	1200 mA	100 mV pp	1828729
18 V	1000 mA	180 mV pp	1828730
24 V	750 mA	180 mV pp	1828731

**GPP 30** FW 7540

**30 Watts**

Output data			Worldwide
Voltage	Current	Ripple Voltage	Order No.
5 V	5000 mA	50 mV pp	1893886
6 V	4200 mA	60 mV pp	1893887
7.5 V	3600 mA	75 mV pp	1893888
9 V	3000 mA	90 mV pp	1893889
12 V	2500 mA	120 mV pp	1893890
15 V	2000 mA	150 mV pp	1893891
18 V	1650 mA	180 mV pp	1893892
24 V	1250 mA	240 mV pp	1893893
48 V	625 mA	240 mV pp	1893894



## Switchmode Power Supplies

# MPP Series

with exchangeable primary adapters

All products conform to IEC 60950

### Applications

- Weighing technology
- WLAN modems
- Bluetooth
- Communication accessories
- Measurement technology
- LED applications
- Laser technology
- IT accessories
- Safety technology

### Characteristics

- Universal input 100 to 240 V AC
- Constant voltage, current limited
- Exchangeable primary adapters
- Low standby power  $\leq 0.3$  Watts
- Continuously short circuit proof
- High efficiency

### Technical data

#### Input voltage

100 to 240 V AC ( $\pm 10\%$ )

#### Input current

150 mA (MPP 6),  
400 mA (MPP 15),  
700 mA (MPP 30)

#### Frequency

50 to 60 Hz

#### Efficiency

80% typ. at full load, resp. 75% (MPP 6)

#### EMC

Conforms to  
EN 55011, EN 55022/B,  
FCC 47 part 15, EN 61000-3-2,  
EN 61000-4-2, EN 61000-4-3,  
EN 61000-4-4, EN 61000-4-5,  
EN 61000-4-6, EN 61000-4-11

#### Output voltage tolerance

$\pm 2\%$  (without consideration of the output lead)

#### Environmental specification

**Operating temperature** 0 to 40° C at maximum load

**Storage temperature** -40 to 70° C

**Humidity** 5% to 95% non condensing

**Input transient susceptibility** Complies with IEC 61000 requirements

#### Safety specification

**Standards** Fulfils class II, SELV according to following standards:  
IEC/EN/UL 60950

#### Reliability specification

**MTBF calculation** 200.000 hours at maximum load and an ambient temperature of 25° C (in accordance with MIL-HDBK-217)

#### Mechanical specification

**Weight approx.** 105 g (MPP 6), 160 g (MPP 15), 255 g (MPP 30)

**Plug connector** AC input:  
FRIWO exchangeable mains plug system:  
EURO, UK, USA/Japan, Australia, IEC  
DC output:  
Universal output plug system (page 34)

For primary adapters see page 34

## MPP 6 FW 7650



## 6 Watts

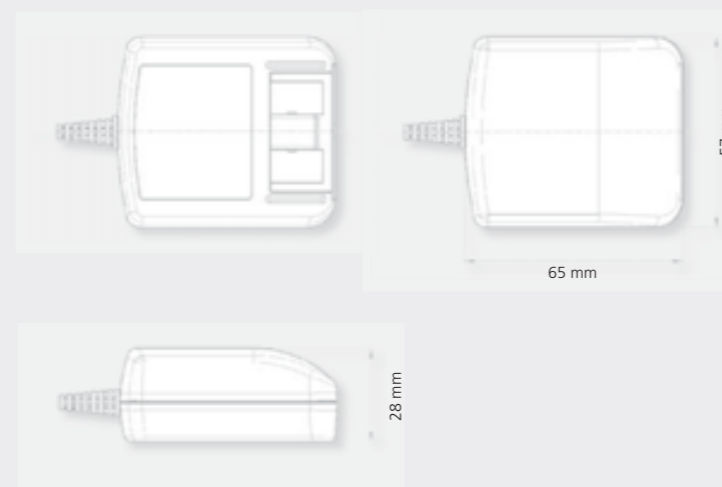

## MPP 15 FW 7520



## 15 Watts

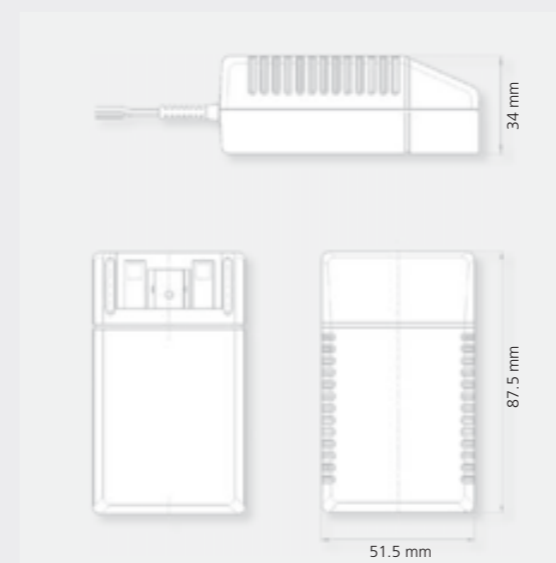

## MPP 30 FW 7530



## 30 Watts

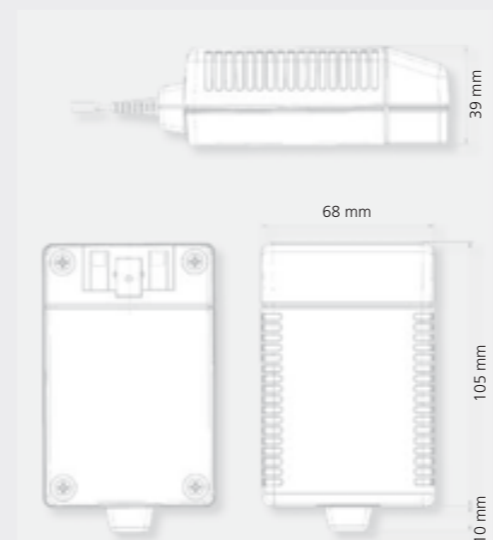

Output data			Worldwide
Voltage	Current	Ripple Voltage	Order No.
5 V	1000 mA	200 mV pp	1814926
6 V	850 mA	180 mV pp	1814927
7.5 V	650 mA	150 mV pp	1814928
9 V	550 mA	150 mV pp	1814929
12 V	450 mA	150 mV pp	1814930
15 V	360 mA	150 mV pp	1814931
18 V	300 mA	150 mV pp	1814932
24 V	220 mA	150 mV pp	1814933

Output data			Worldwide
Voltage	Current	Ripple Voltage	Order No.
5 V	3000 mA	75 mV pp	1894100
6 V	2500 mA	75 mV pp	1894101
7.5 V	2000 mA	75 mV pp	1894102
9 V	1800 mA	90 mV pp	1894103
12 V	1300 mA	120 mV pp	1894104
15 V	1000 mA	150 mV pp	1894105
18 V	850 mA	180 mV pp	1894106
24 V	650 mA	240 mV pp	1894107
48 V	375 mA	100 mV pp	1894108

Output data			Worldwide
Voltage	Current	Ripple Voltage	Order No.
5 V	5000 mA	50 mV pp	1894090
6 V	4200 mA	60 mV pp	1894091
7.5 V	3600 mA	75 mV pp	1894092
9 V	3000 mA	90 mV pp	1894093
12 V	2500 mA	120 mV pp	1894094
15 V	2000 mA	150 mV pp	1894095
18 V	1650 mA	180 mV pp	1894096
24 V	1250 mA	240 mV pp	1894097



## Switchmode Power Supplies

# DT Series

All products conform to IEC 61558 and 60950

### Applications

- Audio
- Bluetooth/WLAN
- Digital cameras
- Communication accessories
- Measurement and weighing technology
- MPEG Players
- Modems DSL, ADSL, VDSL
- Safety technology
- Laboratory equipment

### Characteristics

- Universal input 100 to 240 V AC
- Constant voltage, current limited
- Low standby power
  - ≤ 0.3 Watts (DT 12) resp.
  - ≤ 0.5 Watts (DT 60, DT 100, DT 150)
- Continuously short circuit proof
- High efficiency

### Technical data

**Input voltage** 100 to 240 V AC (± 10%)  
**Input current** 300 mA (DT 12), 1500 mA (DT 100), 1600 mA (DT 60), 2000 mA (DT 150)  
**Frequency** 50 to 60 Hz  
**Efficiency** up to 91% typ. at full load  
**EMC** Conforms to EN 55011, EN 55022/B, FCC 47 part 15, EN 61000-3-2, EN 61000-4-2, EN 61000-4-3, EN 61000-4-4, EN 61000-4-5, EN 61000-4-6, EN 61000-4-11  
**Output voltage tolerance** ±2% (without consideration of the output lead)

### Environmental specification

**Operating temperature** 0 to 40° C at maximum load  
**Storage temperature** -10 to 70° C  
**Humidity** 10% to 95% non condensing  
**Input transient susceptibility** Complies with IEC 61000 requirements

### Safety specification

**Standards** Fulfils class II, SELV according to following standards: IEC/EN/UL 60950, DT 100 and DT 150 fulfils class I.

### Reliability specification

**MTBF calculation** 200.000 hours at maximum load and an ambient temperature of 25° C (in accordance with MIL-HDBK-217)

### Mechanical specification

**Weight approx.** 135 g (DT 12), 260 g (DT 60), 500 g (DT 100), 622 g (DT 150)  
**Plug connector** AC input: 2-pole IEC 320, C8-socket (DT 12, DT 60), C14-socket (DT 100, DT 150)  
 DC output (not DT 150): Universal output plug system (page 34)

For power cords see page 34

DT 12 FW 7402

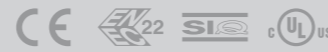

12 Watts

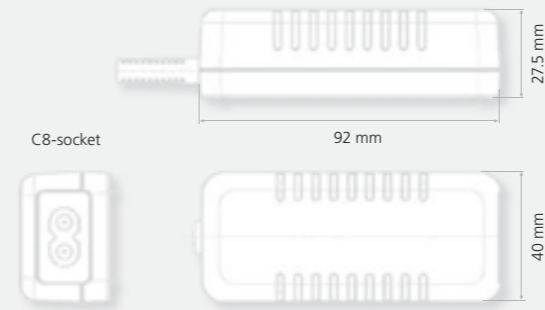

DT 60 DT 60



60 Watts

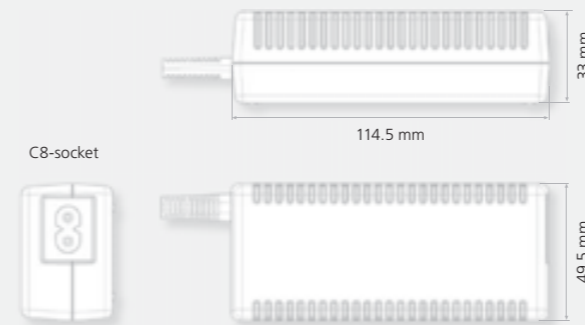

DT 100 DT 100



100 Watts

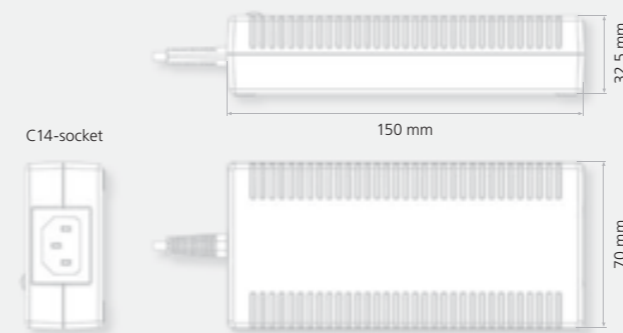

DT 150 DT 150



150 Watts

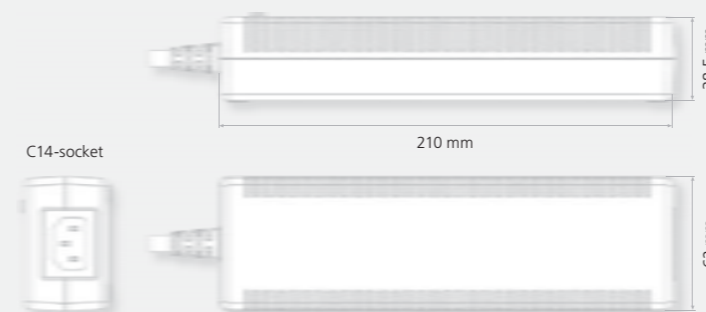

Output data			Worldwide
Voltage	Current	Ripple Voltage	Order No.
5 V	2000 mA	200 mV pp	1893922
5,9 V	1700 mA	200 mV pp	1893923
7,5 V	1400 mA	180 mV pp	1893924
9 V	1200 mA	135 mV pp	1893925
12 V	1000 mA	180 mV pp	1893926
15 V	800 mA	112 mV pp	1893927
18 V	660 mA	135 mV pp	1893928
24 V	500 mA	300 mV pp	1893929
48 V	250 mA	480 mV pp	1893930

Output data			Worldwide
Voltage	Current	Ripple Voltage	Order No.
12 V	5000 mA	250 mV pp	1830993
15 V	4000 mA	250 mV pp	1830994
18 V	3300 mA	250 mV pp	1830995
24 V	2500 mA	250 mV pp	1831363

Output data			Worldwide
Voltage	Current	Ripple Voltage	Order No.
24 V	4170 mA	240 mV pp	1891551

Output data			Worldwide
Voltage	Current	Ripple Voltage	Order No.
24 V	6250 mA	240 mV pp	1894781





# Switchmode Power Supplies Medical Series

with exchangeable primary adapters

All products conform to IEC 60601-1

## Applications

- Blood analysers
- Patient monitors
- Measuring equipment
- Laboratory equipment
- Inhalers
- Patient lifts

## Characteristics

- Universal input 100 to 240 V AC
- Exchangeable primary adapters
- Constant voltage, current limited
- Green LED indicator
- Low leakage current  $\leq 10 \mu\text{A}$
- Low standby power
- 2 x MOPP
- Continuously short circuit proof

## Technical data

### Input voltage Input current

100 to 240 V AC ( $\pm 10\%$ )  
250 to 110 mA (GPP6)  
205 to 110 mA (GPP 10)  
400 to 200 mA (GPP 18)  
200 to 100 mA (GPP USB Medical)

### Frequency Efficiency EMC

50 to 60 Hz  
80% typ. at full load  
Conforms to  
EN 55011, EN 55022/B, IEC 60601-1-2,  
FCC 47 Teil 15, EN 61000-3-2,  
EN 61000-4-2, EN 61000-4-3,  
EN 61000-4-4, EN 61000-4-5,  
EN 61000-4-6, EN 61000-4-11

### Output voltage tolerance

$\pm 2\%$  (without consideration of the output lead)

## Environmental specification

**Operating temperature** 0 to 40° C at maximum load  
**Storage temperature** -40 to 70° C  
**Humidity** 5 % to 95 % non condensing  
**Input transient susceptibility** Complies with IEC 61000 requirements

## Safety specification

**Standards** Fulfils class II, SELV according to following standards:  
ES 60601, IEC 60601-1, UL 2601, CE label,  
fulfils medical application class B/BF/CF

## Reliability specification

**MTBF calculation** 200,000 hours at maximum load  
and an ambient temperature of 25° C  
(in accordance with MIL-HDBK-217)

## Mechanical specification

**Weight** 80 g (GPP 6), 113 g (GPP 10), 170 g (GPP 18),  
60 g (GPP USB Medical)  
**Plug connector** AC input:  
FRIWO exchangeable mains plug system:  
EURO, UK, USA/Japan, Australia, IEC  
DC output:  
Universal output plug system (page 34)  
USB socket: Type A (GPP USB Medical)

For primary adapters see page 34

## GPP 6 FW 7662M



## 6 Watts

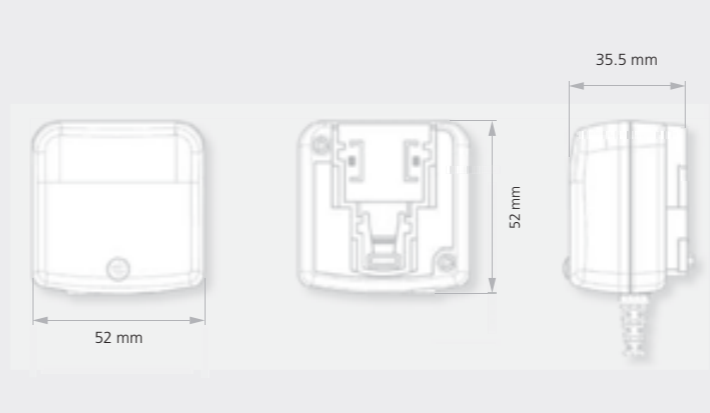

## GPP 10 FW 7660M



## 10 Watts

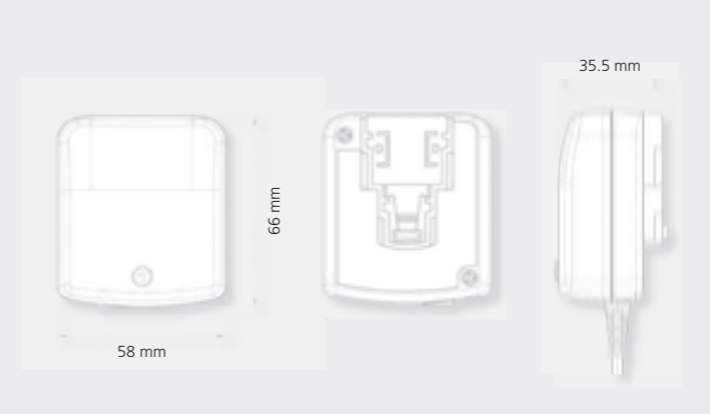

## GPP 18 FW 7556M



## 18 Watts

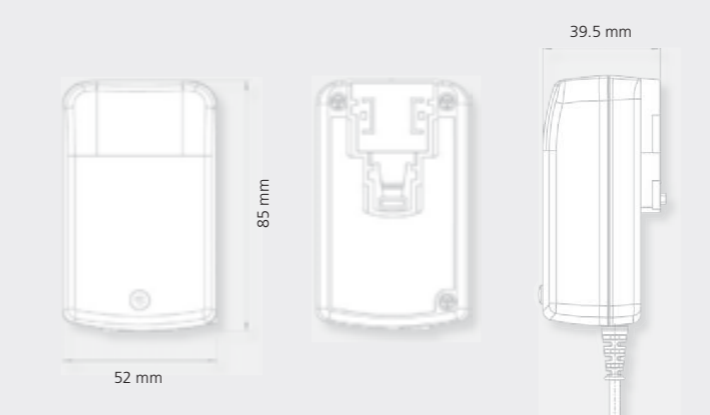

## GPP USB Medical



## 7.5 Watts

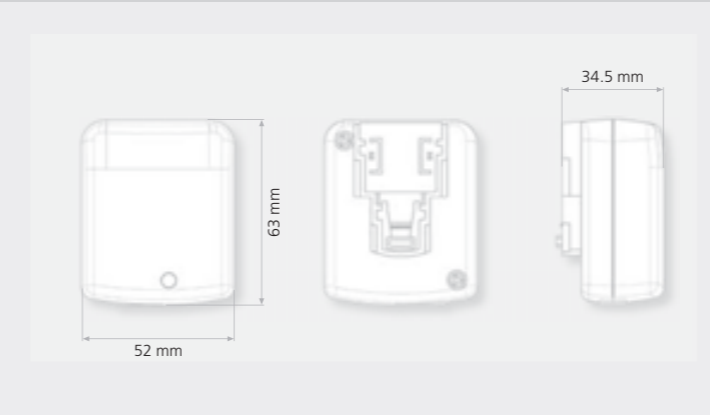

Output data			Worldwide
Voltage	Current	Ripple Voltage	Order No.
5 V	1100 mA	200 mV pp	1891201
6 V	1000 mA	200 mV pp	1891653
7.5 V	800 mA	200 mV pp	1891654
9 V	600 mA	200 mV pp	1891655
12 V	500 mA	200 mV pp	1891656
15 V	400 mA	200 mV pp	1891657
18 V	330 mA	200 mV pp	1891658
24 V	250 mA	200 mV pp	1891659

Output data			Worldwide
Voltage	Current	Ripple Voltage	Order No.
5 V	1600 mA	75 mV pp	1950062
6 V	1400 mA	75 mV pp	1950064
7.5 V	1200 mA	75 mV pp	1950063
9 V	1000 mA	75 mV pp	1950068
12 V	800 mA	75 mV pp	1950082
15 V	700 mA	75 mV pp	1950067
18 V	560 mA	125 mV pp	1950066
24 V	420 mA	125 mV pp	1950065

Output data			Worldwide
Voltage	Current	Ripple Voltage	Order No.
5 V	3000 mA	75 mV pp	1890854
6 V	2500 mA	75 mV pp	1890920
7.5 V	2000 mA	75 mV pp	1890925
9 V	1800 mA	90 mV pp	1890924
12 V	1500 mA	100 mV pp	1890856
15 V	1200 mA	100 mV pp	1890923
18 V	1000 mA	180 mV pp	1890922
24 V	750 mA	180 mV pp	1890855

Output data			Worldwide
Voltage	Current	Ripple Voltage	Order No.
5 V	1500 mA	$\leq 50 \text{ mV pp}$	1895382



# Switchmode Power Supplies Medical Series

with exchangeable primary adapters  
(MPP 15/30)

All products conform to IEC 60601-1

### Applications

- Blood analysers
- Patient monitors
- Measuring equipment
- Laboratory equipment
- Inhalers
- Patient lifts

### Characteristics

- Universal input 100 to 240 V AC
- Constant voltage, current limited
- Green LED indicator
- Low standby power
- Continuously short circuit proof
- Exchangeable primary adapters (MPP 15/30)
- 2 x MOPP
- Low leakage current  $\leq 10 \mu\text{A}$

### Technical data

**Input voltage** 100 to 240 V AC ( $\pm 10\%$ )  
**Input current** 200 to 80 mA (PP 8)  
 350 to 150 mA (MPP 15)  
 700 to 350 mA (MPP 30)

**Frequency** 50 to 60 Hz  
**Efficiency** 80 % typ. at full load, PP 8 75 %  
**EMC** Conforms to

EN 55011, EN 55022/B, IEC 60601-1-2  
 FCC 47 Teil 15, EN 61000-3-2,  
 EN 61000-4-2, EN 61000-4-3,  
 EN 61000-4-4, EN 61000-4-5,  
 EN 61000-4-6, EN 61000-4-11

**Output voltage tolerance**  $\pm 2\%$  (without consideration of the output lead)

### Environmental specification

**Operating temperature** 0 to 40° C at maximum load  
**Storage temperature** -40 to 70° C, PP 8 (-20 to 70° C)  
**Humidity** 5 % to 95 % non condensing  
**Input transient susceptibility** Complies with IEC 61000 requirements

### Safety specification

**Standards** Fulfils class II, SELV according to following standards:  
 ES 60601, IEC 60601-1, UL 2601, CE label,  
 fulfils medical application class B/BF/CF

### Reliability specification

**MTBF calculation** 200,000 hours at maximum load  
 and an ambient temperature of 25° C  
 (in accordance with MIL-HDBK-217)

### Mechanical specification

**Weight approx.** 110 g (PP 8), 160 g (MPP 15), 255 g (MPP 30)  
**Plug connector** AC input:  
 FRIWO exchangeable mains plug system:  
 EURO, UK, USA/Japan, Australia, IEC  
 PP 8: EURO, UK, USA/Japan  
 DC output:  
 Universal output plug system (page 34)

For primary adapters see page 34

**PP 8** FW 7333SM



**8 Watts**

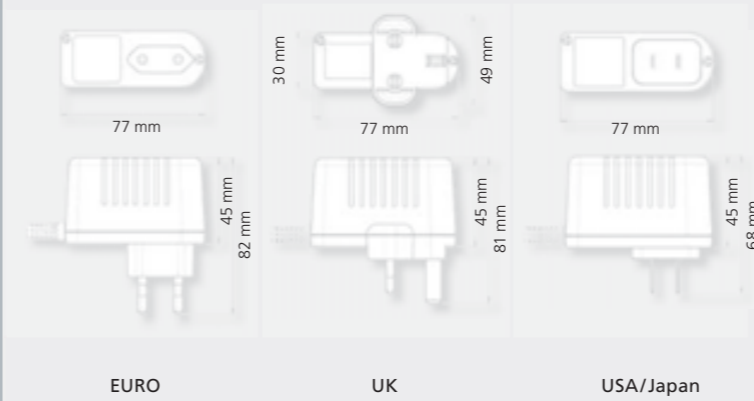

Output data		Ripple	EURO	USA/Japan	UK
Voltage	Current	Voltage	Order No.	Order No.	Order No.
5 V	1300 mA	200 mV pp	1829500	1829589	1829571
6 V	1150 mA	180 mV pp	1829501	1829590	1829572
7.5 V	900 mA	150 mV pp	1829502	1829591	1829573
9 V	800 mA	150 mV pp	1829503	1829592	1829574
12 V	700 mA	150 mV pp	1829504	1829593	1829575
15 V	530 mA	150 mV pp	1829505	1829594	1829576
18 V	440 mA	150 mV pp	1829506	1829595	1829577
24 V	330 mA	150 mV pp	1829507	1829596	1829578

**MPP 15** FW 7555M



**15 Watts**



Output data			Worldwide
Voltage	Current	Ripple Voltage	Order No.
5 V	2400 mA	75 mV pp	1883256
6 V	2100 mA	75 mV pp	1883257
7.5 V	1700 mA	75 mV pp	1883258
9 V	1500 mA	90 mV pp	1883259
12 V	1250 mA	120 mV pp	1883260
15 V	1000 mA	150 mV pp	1883261
18 V	840 mA	180 mV pp	1883262
24 V	625 mA	240 mV pp	1883263

**MPP 30** FW 7362M



**30 Watts**

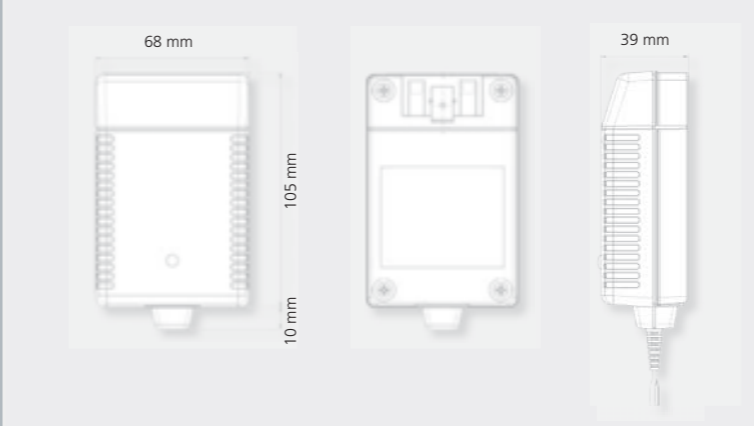

Output data			Worldwide
Voltage	Current	Ripple Voltage	Order No.
5 V	4000 mA	75 mV pp	1883264
6 V	3600 mA	75 mV pp	1883265
7.5 V	3300 mA	75 mV pp	1883266
9 V	3000 mA	90 mV pp	1883267
12 V	2500 mA	100 mV pp	1883268
15 V	2000 mA	100 mV pp	1883269
18 V	1660 mA	120 mV pp	1883270
24 V	1250 mA	120 mV pp	1883271



# Switchmode Power Supplies Medical Series

All products conform to IEC 60601-1

### Applications

- Blood analysers
- Patient monitors
- Measuring equipment
- Laboratory equipment
- Inhalers
- Patient lifts

### Characteristics

- Universal input 100 to 240 V AC
- Constant voltage, current limited
- Green LED indicator
- Leakage current  $\leq 10 \mu\text{A}$   
(DT 80  $\leq 100 \mu\text{A}$ , DT 150  $\leq 100 \mu\text{A}$ )
- Continuously short circuit proof
- 2 x MOPP

### Technical data

**Input voltage** 100 to 240 V AC ( $\pm 10\%$ )  
**Input current** 230 to 140 mA (DT 12)  
 1.100 to 500 mA (DT 50)  
 1.700 to 850 mA (DT 80)  
 2.000 to 700 mA (DT 150)

**Frequency** 50 to 60 Hz  
**Efficiency** 90 % typ. at full load  
**EMC** Conforms to

EN 55011, EN 55022/B, IEC 60601-1-2  
 FCC 47 part 15, EN 61000-3-2,  
 EN 61000-4-2, EN 61000-4-3,  
 EN 61000-4-4, EN 61000-4-5,  
 EN 61000-4-6, EN 61000-4-11

**Output voltage tolerance**  $\pm 2\%$  (without consideration of the output lead)

### Environmental specification

**Operating temperature** 0 to 40° C at maximum load  
**Storage temperature** -40 to 70° C  
**Humidity** 5 % to 95 % non condensing  
**Input transient susceptibility** Complies with IEC 61000 requirements

### Safety specification

**Standards** Fulfils class II, SELV according to following standards:  
 IEC 60601-1, UL 2601, ES 60601-1  
 fulfils medical application class B/BF/CF  
 (DT 12/ DT 50) and B/BF (DT 80, DT 150),  
 class I DT 150

### Reliability specification

**MTBF calculation** 200,000 hours at maximum load  
 and an ambient temperature of 25° C  
 (in accordance with MIL-HDBK-217)

### Mechanical specification

**Weight approx.** 135 g (DT 12), 295 g (DT 50),  
 350 g (DT 80), 622 g (DT 150)  
**Plug connector** AC input: 2-pole IEC 320,  
 C8-socket (DT 12, DT 50, DT 80)  
 C14-socket (DT 150)  
 DC output (not DT 150):  
 Universal output plug system (page 34)

For power cords see page 34

**DT 12** FW 7401M



CE c US

**12 Watts**

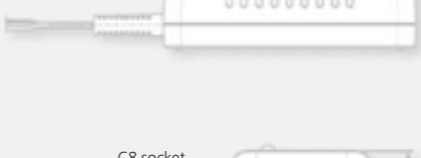

C8 socket



40 mm  
92 mm

**DT 50** FW 7405M



CE c US

**50 Watts**



C8 socket



38.1 mm  
130 mm  
60 mm

**DT 80** FW 7488M



CE c US

**80 Watts**



C8 socket

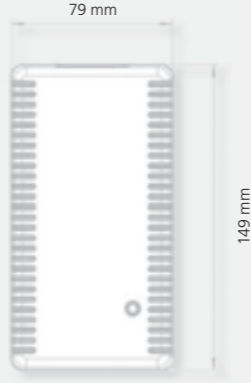

79 mm  
149 mm  
50 mm

**DT 150** DT 150M



CE c US

**150 Watts**



C14 socket



38.5 mm  
210 mm  
62 mm

Output data			Worldwide
Voltage	Current	Ripple Voltage	Order No.
5 V	2000 mA	120 mV pp	1826391
6 V	1700 mA	120 mV pp	1826392
7.5 V	1400 mA	115 mV pp	1826393
9 V	1200 mA	135 mV pp	1826394
12 V	1000 mA	180 mV pp	1826395
15 V	800 mA	112 mV pp	1826396
18 V	660 mA	135 mV pp	1826397
24 V	500 mA	300 mV pp	1826398

Output data			Worldwide
Voltage	Current	Ripple Voltage	Order No.
5 V	5000 mA	120 mV pp	1890649
12 V	3800 mA	120 mV pp	1890650
15 V	3000 mA	120 mV pp	1890839
24 V	2200 mA	120 mV pp	1825898

Output data			Worldwide
Voltage	Current	Ripple Voltage	Order No.
12 V	5500 mA	120 mV pp	1890865
15 V	5000 mA	120 mV pp	1828339
24 V	3300 mA	120 mV pp	1890981

Output data			Worldwide
Voltage	Current	Ripple Voltage	Order No.
24 V	6250 mA	240 mV pp	1893142



## Switchmode Power Supplies USB Series

with exchangeable primary adapters  
(GPP USB, GUP)

All products conform to IEC 60950

### Applications

- Bluetooth
- Digital cameras
- Wireless communication accessories
- PDAs
- Household applications
- MP3 Players
- E-Books

### Characteristics

- Universal input 100 to 240 V AC
- Constant voltage, current limited
- Exchangeable primary adapters (GPP USB)
- Low standby power  $\leq 0.3$  Watts
- Continuously short circuit proof
- Low weight
- Compact design

### Technical data

<b>Input voltage</b>	100 to 240 V AC ( $\pm 10\%$ )
<b>Input current</b>	100 mA (PP USB, GUP), 75 mA (GPP USB) 150 mA (PP Mini USB)
<b>Frequency</b>	50 to 60 Hz
<b>Efficiency</b>	70 % typ. at full load
<b>EMC</b>	Conforms to EN 55011, EN 55022/B, EN 55024, FCC 41 part 15, EN 61000-3-2, EN 61000-4-2, EN 61000-4-3, EN 61000-4-4, EN 61000-4-5, EN 61000-4-6, EN 61000-4-11
<b>Output voltage tolerance</b>	$\pm 2\%$ (without consideration of the output lead)

### Environmental specification

<b>Operating temperature</b>	0 to 40° C at maximum load
<b>Storage temperature</b>	-20 to 70° C
<b>Humidity</b>	5 % to 95 % non condensing
<b>Input transient susceptibility</b>	Complies with IEC 61000 requirements

### Safety specification

<b>Standards</b>	Fulfils class II, SELV according to following standards: EN 60950/IEC 60950, UL 60950
------------------	--

### Reliability specification

<b>MTBF calculation</b>	200,000 hours at maximum load and an ambient temperature of 25° C (in accordance with MIL-HDBK-217)
-------------------------	---

### Mechanical specification

<b>Weight approx.</b>	36 g (PP USB), 50 g (GPP USB), 35 g (GUP), 25 g (PP Mini USB)
<b>Plug connector</b>	AC input: FRIWO exchangeable mains plug system (GPP USB, GUP): EURO, UK, USA/Japan, Australia, IEC DC output: USB socket type A

For primary adapters see page 34

**GPP USB** FW 7711

**3.5 Watts**

Dimensions: 63 mm (width), 52 mm (height), 34.5 mm (depth), 28 mm (width of USB port).

Output data			Worldwide
Voltage	Current	Ripple Voltage	Order No.
<b>5 V</b>	<b>700 mA</b>	<b>200 mV pp</b>	<b>1891371</b>

**PP USB** FW 7710 (700 mA)  
FW 7715 (1.000 mA)

**3.5 / 5 Watts**

Dimensions: 26 mm (width), 64 mm (width), 53 mm (height), 35 mm (height), 26 mm (width).

EURO USA/Japan

Output data		Ripple Voltage	EURO	USA/Japan	UK
Voltage	Current		Order No.	Order No.	Order No.
<b>5 V</b>	<b>700 mA</b>	<b>200 mV pp</b>	<b>1891526</b>	<b>1891525</b>	<b>1832723</b>
<b>5 V</b>	<b>1000 mA</b>	<b>300 mV pp</b>	<b>1895751</b>	<b>1895776</b>	<b>1895777</b>

**GUP** FW 7712

**4.5 Watts**

Dimensions: 37 mm (height), 53 mm (width), 29 mm (depth).

Output data			Worldwide
Voltage	Current	Ripple Voltage	Order No.
<b>5 V</b>	<b>900 mA</b>	<b>200 mV pp</b>	<b>1894059</b>

**PP Mini USB** FW 7713

**5 Watts**

Dimensions: 18 mm (width), 40 mm (width), 65 mm (height), 22 mm (width), 35.5 mm (width), 54 mm (height).

EURO USA/Japan

Output data		Ripple Voltage	EURO	USA
Voltage	Current		Order No.	Order No.
<b>5 V</b>	<b>1000 mA</b>	<b>300 mV pp</b>	<b>1894289</b>	<b>1894290</b>
<b>5 V</b>	<b>1000 mA</b>	<b>300 mV pp</b>	<b>1896014<sup>1</sup></b>	<b>1896019<sup>1</sup></b>

<sup>1</sup> Color: white



## Switchmode Power Supplies CPP Series

All products conform to IEC 60950;  
PP18 additional to IEC 60601-1

### Applications

- Router
- E-Books
- Blood analysers
- Inhalers

### Characteristics

- Universal input 100 to 240 V AC
- Constant voltage, current limited
- Continuously short circuit proof
- Low weight
- Low standby power  $\leq 0.3$  Watts
- 2 x MOPP (PP18)

### Technical data

**Input voltage** 100 to 240 V AC ( $\pm 10\%$ )  
**Input current** 300 mA (PP12), 550 mA (PP30),  
400-180 mA (PP18)

**Frequency** 50 to 60 Hz

**Efficiency** up to 78% typ. at full load  
**EMC** Conforms to EN55011, EN 55022/B, EN55024,  
FCC41 part 15, EN61000-3-2, EN 61000-4-2,  
EN61000-4-3, EN 61000-4-4, EN 61000-4-5, EN  
61000-4-6, EN 61000-4-11, EN 60601-1-2

**Output voltage tolerance**  $\pm 2\%$  (without consideration of the output lead)

### Environmental specification

**Operating temperature** 0 to 40°C at maximum load  
**Storage temperature** -20 to +70°C  
**Humidity** 5% to 95% non condensing  
**Input transient susceptibility** Complies with IEC 61000 requirements

### Safety specification

**Standards** Fulfils class II, SELV according to  
following standards:  
EN/IEC/UL 60950, EN/IEC 60601-1 (PP18)

### Reliability specification

**MTBF calculation** 200,000 hours at maximum load  
and an ambient temperature of 25° C  
(in accordance with MIL-HDBK-217)

### Mechanical specification

**Weight approx.** 120g (PP12), 125g (PP18), 150g (PP30)  
**Plug connector** AC input: EURO  
DC output:  
Universal output plug system (page 34)

PP 12 FW 7599



12 Watts

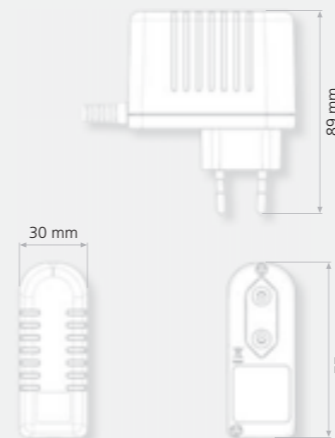

PP 18 FW 7598 M



18 Watts

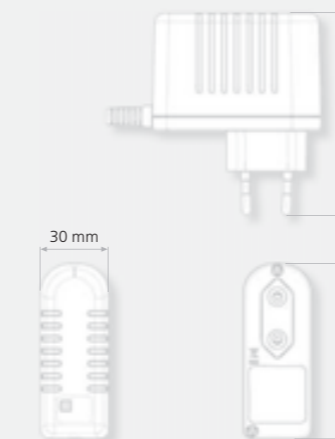

PP 30 FW 7583



30 Watts

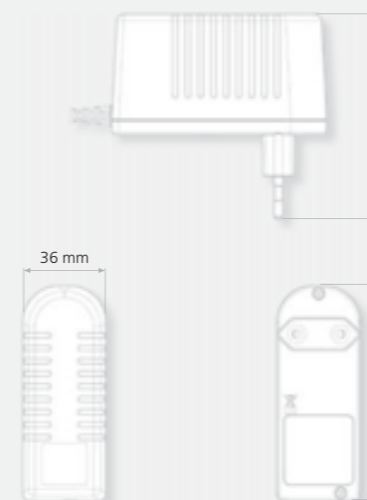

Output data			Euro
Voltage	Current	Ripple Voltage	Order No.
12 V	1000 mA	120 mV pp	1894626

Output data			Euro
Voltage	Current	Ripple Voltage	Order No.
12 V	1500 mA	200 mV pp	1896903

Output data			Euro
Voltage	Current	Ripple Voltage	Order No.
12 V	2000 mA	300 mV pp	1896904



## Switchmode Power Supplies In-wall Series

All products conform to  
IEC 61558, 60335

### Applications

- Safety technology
- Water taps
- Shutter control
- Door opener
- LED applications (UP 6)
- E-Books
- PDAs
- MP3-Players
- Tablets

### Characteristics

- Universal input 100 to 240 V AC
- Constant voltage, current limited
- Low standby power  
≤ 0.3 Watts
- High output power
- Continuously short circuit proof
- Compact design
- IP 64 protection class

### Technical data

<b>Input voltage</b>	100 to 240 V AC (± 10 %)
<b>Input current</b>	150 mA (UP 6), 400 mA (UP 12, UP 18), 180 mA (UP USB)
<b>Frequency</b>	50 to 60 Hz
<b>Efficiency</b>	up to 80 % typ. at full load
<b>EMC</b>	Conforms to EN 55011, 55014, EN 55022/B, EN 55024, FCC 41 part 15, EN 61000-3-2, EN 61000-4-2, EN 61000-4-3, EN 61000-4-4, EN 61000-4-5, EN 61000-4-6, EN 61000-4-11, ±2% (without consideration of the output lead)
<b>Output voltage tolerance</b>	±2% (without consideration of the output lead)

### Environmental specification

<b>Operating temperature</b>	0 to 40° C at maximum load
<b>Storage temperature</b>	- 20 to 70° C
<b>Humidity</b>	5 % to 95 % non condensing
<b>Input transient susceptibility</b>	Complies with IEC 61000 requirements
<b>Temperature range</b>	0 to 70° C

### Safety specification

<b>Standards</b>	Fulfils class II, SELV according to following standards: EN 61558/IEC 61558
------------------	---

### Reliability specification

<b>MTBF calculation</b>	200,000 hours at maximum load and an ambient temperature of 25° C (in accordance with MIL-HDBK-217)
-------------------------	---

### Mechanical specification

<b>Weight approx.</b>	95 g (UP 6), 130 g (UP 12), 130 g (UP 18), 70 g (UP USB)
<b>Plug connector</b>	AC input: 150 mm cable (UP 6, UP 12, UP 18) Spring clip 2 x 2,5 mm <sup>2</sup> (UP USB) DC output: 150 mm cable (UP 6, UP 12, UP 18) USB-socket type A (UP USB)

**Optional – upon request:** Customer-specific output voltages  
Customer-specific cable length

**UP 6** FW 7801



**6 Watts**



**UP 12** FW 7802



**12 Watts**



**UP 18** FW 7803



**18 Watts**



**UP USB** 153380



**7 Watts**

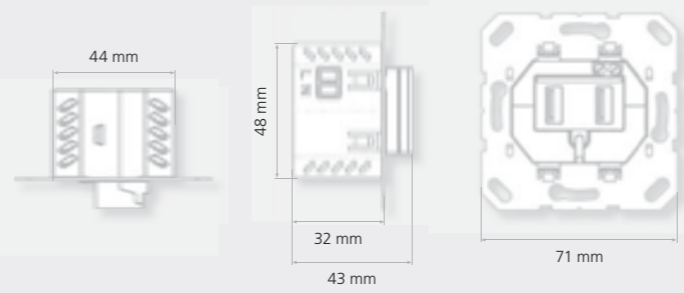

Output data			Worldwide
Voltage	Current	Ripple Voltage	Order No.
4 V	1300 mA	300 mV pp	1891505
5 V	1200 mA	300 mV pp	1894388
6 V	1000 mA	300 mV pp	1891506
9 V	660 mA	300 mV pp	1891507
12 V	500 mA	300 mV pp	1891508
15 V	400 mA	300 mV pp	1891509
18 V	330 mA	300 mV pp	1891510
24 V	250 mA	300 mV pp	1891511

Output data			Worldwide
Voltage	Current	Ripple Voltage	Order No.
12 V	1000 mA	300 mV pp	1891767
24 V	500 mA	300 mV pp	1891768

Output data			Worldwide
Voltage	Current	Ripple Voltage	Order No.
12 V	1500 mA	400 mV pp	1832688
24 V	750 mA	400 mV pp	1891685

Output data			Worldwide
Voltage	Current	Ripple Voltage	Order No.
5 V	1400 mA	300 mV pp	1891648
<b>Also available without support ring</b>			<b>1894529</b>



## Switchmode Power Supplies Open Frame

All products conform to 61558;  
OF 150 additional to 60601-1

### Applications

- Laboratory equipment
- Patient lifts
- Label printers
- Measuring equipment
- Laser
- Lighting
- Automation
- Climate chambers
- Electric tools
- Professional kitchen equipment

### Characteristics

- Universal input 100 to 240 V AC
- Constant voltage, current limited
- Low standby power
- High efficiency
- Continuously short circuit proof
- Leakage current  $\leq 100 \mu\text{A}$
- Small package
- Without active fan

### Technical data

**Input voltage** 100 to 240 V AC ( $\pm 10\%$ )  
**Input current** 1600 mA (OF 65), 2500 mA (OF 100), 1800 mA (OF 150)

**Frequency** 50 to 60 Hz

**Efficiency**  $\geq 87\%$  typ. at full load

**Standby Losses**  $\leq 0.5$  Watts typ.

**EMC** Conforms to  
EN 55011, EN 55022/B, FCC47 part 15,  
EN 61000-3-2, EN 61000-4-2, EN 61000-4-3,  
EN 61000-4-4, EN 61000-4-5, EN 61000-4-6,  
EN 61000-4-11, EN 60601-1-2

**Output voltage tolerance**  $\pm 2\%$

**Power factor**  $\geq 0.9$  typ.

### Environmental specification

**Operating temperature** 0 to 70° C

**Storage temperature** -20 to +70° C

**Humidity** 5% to 95% non condensing

**Input transient susceptibility** Complies with IEC 61000 requirements

### Safety specification

**Standards** Fulfils class I, SELV according to following standards: IEC 60601, UL 2601, fulfils medical application class B/BF

### Reliability specification

**MTBF calculation** typ. 200,000 hours at maximum load and an ambient temperature of 25° C (in accordance with MIL-HDBK-217)

### Mechanical specification

**Weight approx.** 220 g (OF 65), 230 g (OF 100), 340 g (OF 150)  
**Plug connector** Pin connector, flat-pin plug or screw terminal

OF 65 OF65-2

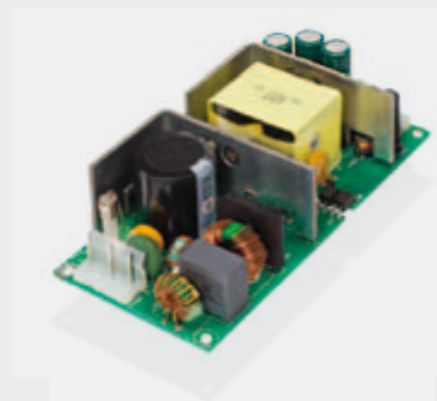

60 Watts

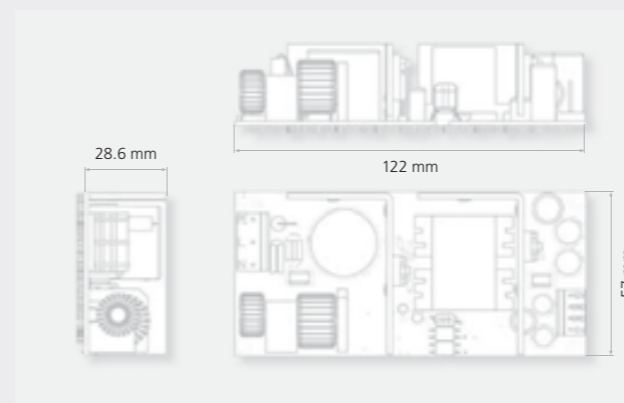

OF 100 OF100

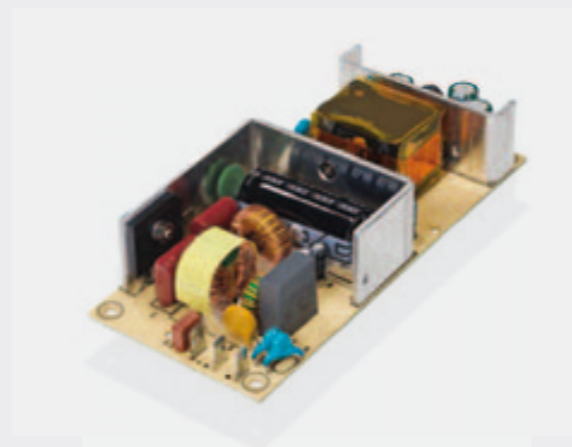

100 Watts

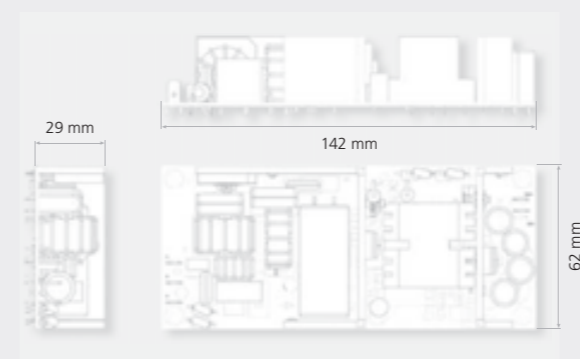

OF 150 OF150

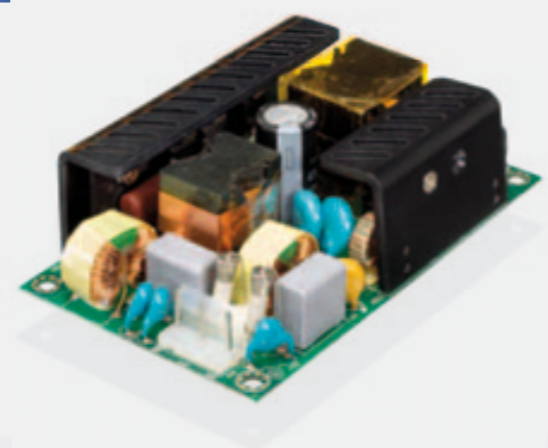
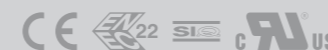

150 Watts

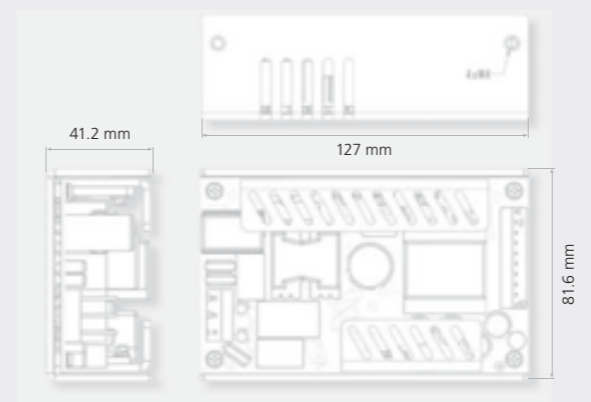

Output data			Worldwide
Voltage	Current	Ripple Voltage	Order No.
5 V	1000 mA	$\leq 75 \text{ mV pp}$	1891628
12 V	5000 mA	$\leq 200 \text{ mV pp}$	

Output data			Worldwide
Voltage	Current	Ripple Voltage	Order No.
12 V	7500 mA	$\leq 150 \text{ mV pp}$	1893590

Output data			Worldwide
Voltage	Current	Ripple Voltage	Order No.
12 V	10500 mA	$\leq 240 \text{ mV pp}$	1893143
also available without U-bracket			1896246
24 V	6250 mA	$\leq 120 \text{ mV pp}$	1893247
also available without U-bracket			1891612
48 V	3125 mA	$\leq 480 \text{ mV pp}$	1893703
also available without U-bracket			1896248



## Switchmode Power Supplies Open Frame

All products conform to 61558;  
OF 250 and OF 450 additional to 60601-1

### Applications

- Laboratory equipment
- Patient lifts
- Label printers
- Measuring equipment
- Laser
- Lighting
- Automation
- Climate chambers
- Electric tools
- Professional kitchen equipment

### Characteristics

- Universal input 100 to 240 V AC
- Constant voltage, current limited
- Low standby power
- High efficiency
- Continuously short circuit proof
- Leakage current  $\leq 100 \mu\text{A}$
- Small package
- Without active fan

### Technical data

<b>Input voltage</b>	100 to 240 V AC ( $\pm 10 \%$ )
<b>Input current</b>	3500 mA (OF 250), 5500 mA (OF 450)
<b>Frequency</b>	50 to 60 Hz
<b>Efficiency</b>	$\geq 87 \%$ typ. at full load
<b>Standby Losses</b>	$\leq 0.5$ Watts typ.
<b>EMC</b>	Conforms to EN 55011, EN 55022/B, FCC47 part 15, EN 61000-3-2, EN 61000-4-2, EN 61000-4-3, EN 61000-4-4, EN 61000-4-5, EN 61000-4-6, EN 61000-4-11, EN 60601-1-2
<b>Output voltage tolerance</b>	$\pm 2 \%$
<b>Power factor</b>	$\geq 0.9$ typ.

### Environmental specification

<b>Operating temperature</b>	0 to 70° C
<b>Storage temperature</b>	-20 to +70° C
<b>Humidity</b>	5 % to 95 % non condensing
<b>Input transient susceptibility</b>	Complies with IEC 61000 requirements

### Safety specification

<b>Standards</b>	Fulfils class I, SELV according to following standards: IEC 60601, UL 2601, fulfils medical application class B/BF
------------------	--

### Reliability specification

<b>MTBF calculation</b>	typ. 200,000 hours at maximum load and an ambient temperature of 25° C (in accordance with MIL-HDBK-217)
-------------------------	--

### Mechanical specification

<b>Weight approx.</b>	600 g (OF 250), 1,250 g (OF 450)
<b>Plug connector</b>	Pin connector, flat-pin plug or screw terminal

OF 250 OF250



**250 Watts**

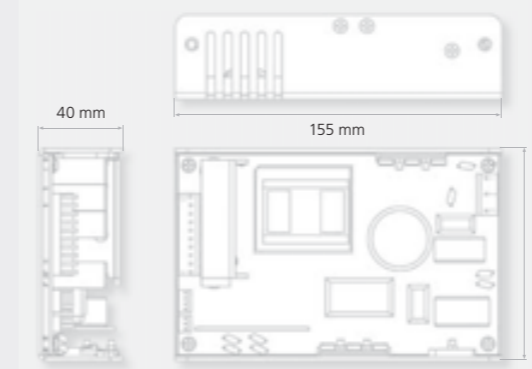

OF 450 OF450



**450 Watts**

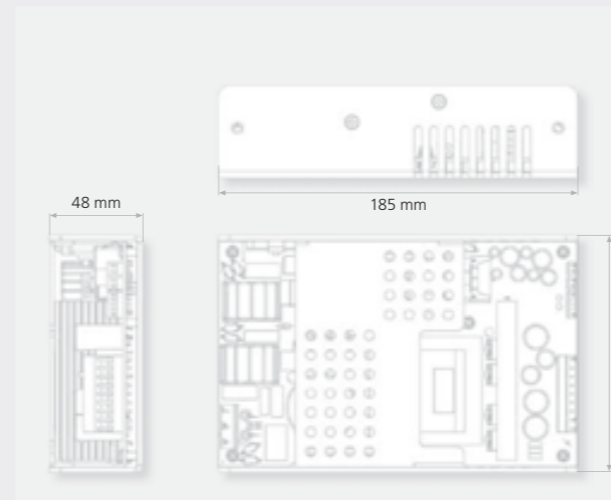

Output data			Worldwide
Voltage	Current	Ripple Voltage	Order No.
5 V	500 mA	50 mV pp	1891705
24 V	10500 mA	240 mV pp	

Output data			Worldwide
Voltage	Current	Ripple Voltage	Order No.
5 V	100 mA	100 mV pp	1893710
12 V	400 mA	100 mV pp	
24 V	18750 mA	240 mV pp	





# Switchmode Chargers

## Chargers

with exchangeable primary adapters (MPP 15 and GPP 18/36)

All products conform to IEC 60335 and IEC 60601-1 (not FW 7574, 7290, 7219)

### Applications

- Medical applications
- Electrical vehicles
- Stair lifts/patient lifts
- Mobile lighting
- Cleaning machines
- Professional photographic technology
- Mobile measuring technology
- Starter batteries
- Diving lamps

### Characteristics

- Universal input 100-240 V AC
- Constant voltage, current limited
- Exchangeable primary adapters (MPP and GPP system)
- Low leakage current
- Low standby power
- LED charge indication
- Continuously short circuit proof
- Reverse polarity protection (not MPP 15 Li-Ion)
- 10KNTC, B = 3977 (GPP 18/36)
- Characteristics:  
PP 8 = IU0U, MPP 15 = IOIU  
GPP 18/36 = IU0

### Technical data

#### Input voltage

100 to 240 V (± 10%)

#### Input current

PP 8 (0,13 – 0,2 A), MPP 15 (0,25 – 0,3 A),  
MPP 30 (0,4 – 0,5 A), GPP 18 (0,2 – 0,4 A)  
GPP 36 (0,18 – 0,45 A)

#### Frequency

50 to 60 Hz

#### Efficiency

75 % at full load

#### EMC

Conforms to  
EN 55011, EN 55022/B, FCC 47 part 15,  
EN 61000-3-2, EN 61000-4-2, EN 61000-4-3,  
EN 61000-4-4, EN 61000-4-5, EN 61000-4-6,  
EN 61000-4-11, EN 60601-1

#### Output current tolerance

± 10%

### Environmental specification

**Operating temperature** 0 to 40° C at maximum load

**Storage temperature** -40 to 70° C

**Humidity** 5 % to 95 % non condensing

**Input transient susceptibility** Complies with IEC 61000 requirements

### Safety specification

#### Standards

Fulfils class II, SELV according to following standards:  
IEC 60601-1, IEC 60335-2-29,  
UL 1310, UL 2601-1

### Reliability specification

#### MTBF calculation

200,000 hours at maximum load and an ambient temperature of 25° C (in accordance with MIL-HDBK-217)

### Mechanical specification

#### Weight

PP 8 Li-Ion (125 g),  
MPP 15 (140 g), MPP 30 (278 g),  
GPP 18 (200 g), GPP 36 (320 g), GPP 36 7S (260 g)

#### Plug connector

AC input:  
MPP/GPP: FRIWO exchangeable mains plug system, PP 8: Euro, USA/Japan, UK  
DC output:  
Universal output plug system (page 34)

For primary adapters see page 34

## Li-Ion

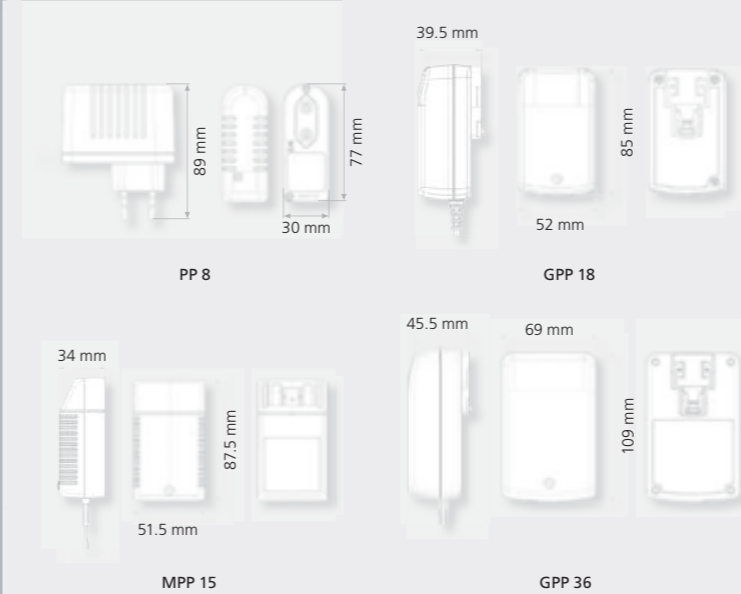

## LiFePO<sub>4</sub>

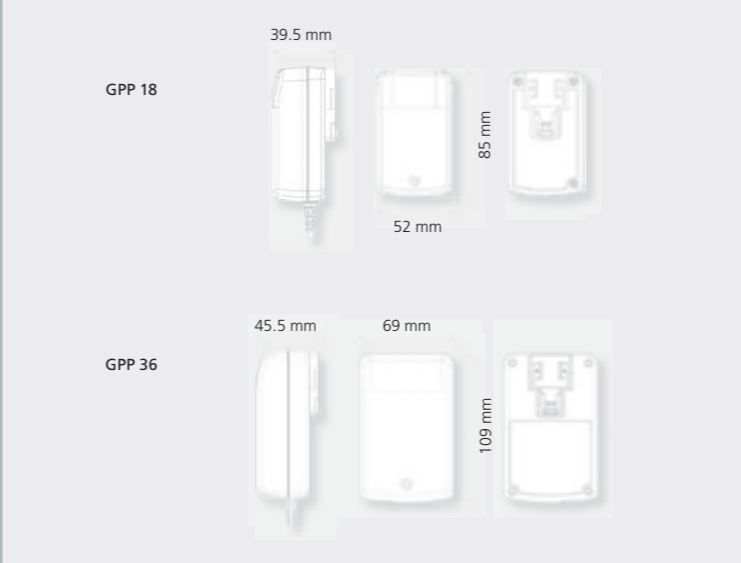

Product	FW Type	Approvals
PP 8 Li-Ion	FW 7574	CE
MPP 15 Li-Ion	FW 7219	CE, D'E, GS, C, SF, US
GPP 18 Li-Ion	FW 7290	CE, SI, C, SF, US
GPP 36 Li-Ion	FW 7300	CE, SI, C, SF, US, SI
GPP 36 Li-Ion	FW 7310 7 Cells	CE
GPP 18 LiFePO <sub>4</sub>	FW 7290	CE, D'E, GS, C, SF, US
GPP 36 LiFePO <sub>4</sub>	FW 7300	CE, D'E, GS, C, SF, US, SI

Output data				EURO	USA/Jap.	UK
Voltage	Current	Cells	Capacity	Housing	Order No.	Order No.
4.1 V	1000 mA	1	0.8 – 10 Ah	PP 8	1890124	1891148 1891149
4.1 V	600 mA	1	0.8 – 10 Ah	PP 8	1828253	1891150 1891151
4.2 V	1000 mA	1	0.8 – 10 Ah	PP 8	1829906	1891161 1891162
4.2 V	600 mA	1	0.8 – 10 Ah	PP 8	1829804	1891159 1891160
Worldwide						
8.4 V	800 mA	2	0.8 – 5 Ah	MPP 15	1826003	
12.6 V	800 mA	3	0.8 – 5 Ah	MPP 15	1826004	
16.8 V	800 mA	4	0.8 – 5 Ah	MPP 15	1826006	
with NTC						
8.4 V	800 mA	2	0.8 – 5 Ah	MPP 15	1826458	
12.6 V	800 mA	3	0.8 – 5 Ah	MPP 15	1826459	
16.8 V	800 mA	4	0.8 – 5 Ah	MPP 15	1826460	
4.2 V	3000 mA*	1	20 Ah	GPP 18	1832657	
8.4 V	1500 mA*	2	20 Ah	GPP 18	1832658	
4.2 V	4000 mA**	1	1.0 – 20 Ah	GPP 36	1834050	
8.4 V	3500 mA**	2	1.0 – 20 Ah	GPP 36	1834051	
12.6 V	2500 mA**	3	1.0 – 20 Ah	GPP 36	1834052	
16.8 V	2000 mA**	4	1.0 – 20 Ah	GPP 36	1834053	
21.0 V	1600 mA**	5	1.0 – 20 Ah	GPP 36	1834054	
29.4 V	1350 mA**	7	1.0 – 20 Ah	GPP 36	1893768	

Output data					Worldwide	
Voltage	Current	Cells	Capacity	Housing	Order No.	
3.6 V	3000 mA*	1	20 Ah	GPP 18	1832654	
7.2 V	1500 mA*	2	20 Ah	GPP 18	1832655	
3.6 V	4000 mA**	1	20 Ah	GPP 36	1834055	
7.2 V	3500 mA**	2	20 Ah	GPP 36	1834056	
10.8 V	2500 mA**	3	20 Ah	GPP 36	1834057	
14.4 V	2000 mA**	4	20 Ah	GPP 36	1834058	
18.0 V	1600 mA**	5	20 Ah	GPP 36	1834059	

\* without NTC 1.5 A  
\*\* without NTC 1.6 A

Charge voltage can be adjusted for specific cell packs. Please observe battery specification.

# Switchmode Chargers

## Chargers

with exchangeable primary adapters (MPP 15/30 and GPP 18/36)

All products conform to IEC 60335 and IEC 60601-1 (not FW 7304, 7219, 7290)

### Applications

- Medical applications
- Electrical vehicles
- Stair lifts/patient lifts
- Mobile lighting
- Cleaning machines
- Professional photographic technology
- Mobile measuring technology
- Starter batteries
- Diving lamps

### Characteristics

- Universal input 100–240 V AC
- Constant voltage, current limited
- Exchangeable primary adapters (MPP and GPP system)
- Low leakage current
- Low standby power
- LED charge indication
- Continuously short circuit proof
- Reverse polarity protection (not PP 8 Pb)
- 10KNTC, B = 3977
- Characteristics: Pb = IU0U

### Technical data

**Input voltage**  
**Input current**

100 to 240 V (± 10%),  
PP 8 (0.13 – 0.2 A),  
MPP 15 (0.25 – 0.3 A), MPP 30 (0.4 – 0.5 A),  
GPP 18 (0.2 – 0.4 A) GPP 36 (0.18 – 0.45 A)

**Frequency**  
**Efficiency**  
**EMC**

50 to 60 Hz  
75 % at full load  
Conforms to  
EN 55011, EN 55022/B, FCC 47 part 15,  
EN 61000-3-2, EN 61000-4-2, EN 61000-4-3,  
EN 61000-4-4, EN 61000-4-5, EN 61000-4-6,  
EN 61000-4-11

**Output current tolerance**

± 10%

### Environmental specification

**Operating temperature** 0 to 40° C at maximum load  
**Storage temperature** -40 to 70° C  
**Humidity** 5 % to 95 % non condensing  
**Input transient susceptibility** Complies with IEC 61000 requirements

### Safety specification

**Standards** Fulfils class II, SELV according to following standards:  
IEC 60601-1 (NiCd/NiMH only MPP 15)  
IEC 60335-2-29, UL 1310, UL 2601-1 (only Li-Ion),  
VDE, CE label, CSA

### Reliability specification

**MTBF calculation** 200,000 hours resp. 100,000 hours (NiCd/NiMH) at maximum load and an ambient temperature of 25° C (in accordance with MIL-HDBK-217)

### Mechanical specification

**Weight approx.** PP 8 Li-Ion (125 g),  
MPP 15 (140 g), MPP 30 (278 g),  
GPP 18 (200 g) GPP 36 (320 g)  
**Plug connector** AC input:  
MPP/GPP: FRIWO exchangeable mains plug system, PP 8: Euro, USA/Japan, UK  
DC output:  
Universal output plug system (page 34)

For primary adapters see page 34

## NiCd/NiMH

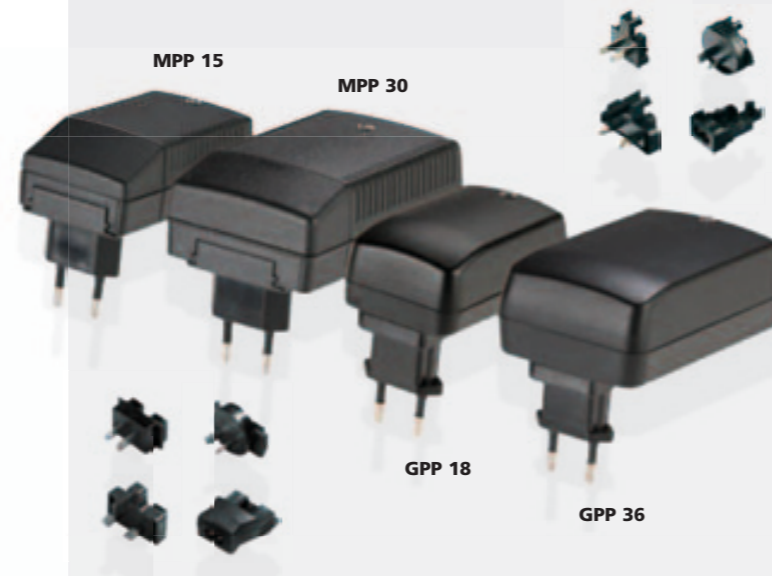

## Pb

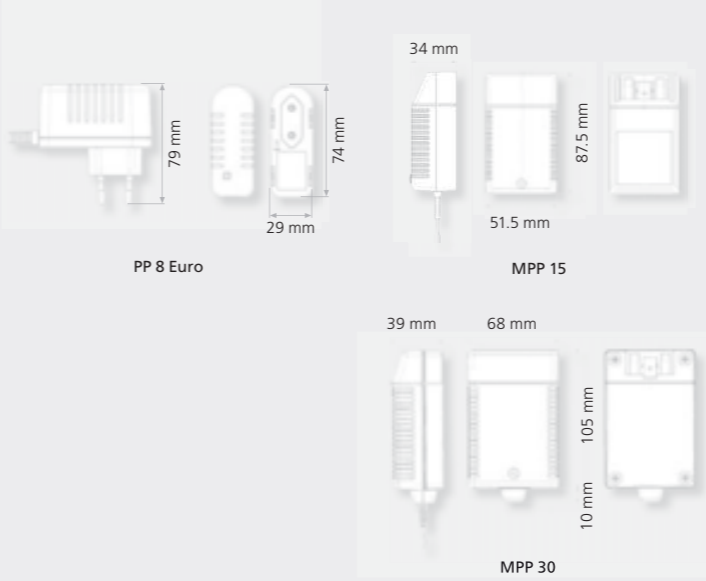

Product	FW Type	Approvals
MPP 15 NiCd/NiMH	FW 7219	CE, D'E, GS, C, RU, US
MPP 30 NiCd/NiMH	FW 7304	CE, D'E, GS, C, RU, US
GPP 18 NiCd/NiMH	FW 7290	CE, SIE, C, SF, US, SI
GPP 36 NiCd/NiMH	FW 7300	CE, SIE, C, SF, US, SI
PP 8 Lead Acid	FW 7118	CE, SIE, C, SF, US, SI
MPP 15 Lead Acid	FW 7218	CE, SIE, C, SF, US, SI
MPP 30 Lead Acid	FW 7318	CE, D'E, GS, C, SF, US, SI

Output data				Switch-off criteria			Worldwide
Capacity	Current	Cells	Housing	TI	TG	-DU	Order No.
3.5 – 7.0 Ah	950 mA	10 – 20	MPP 30	·	·	·	1811894
2.8 – 7.0 Ah	1000 mA	10 – 12	MPP 30	·	·	·	1812609
2.5 – 4.5 Ah	1400 mA	8 – 12	MPP 30	·	·	·	1880408
2.5 – 10.0 Ah	2000 mA	5 – 6	MPP 30	·	·	·	1818681
1.0 – 10.0 Ah	800 mA	4 – 10	MPP 15	·	·	·	1826002
1.0 – 10.0 Ah	800 mA	4 – 10	MPP 15	·	·	·	1890127
1.0 – 35.0 Ah	1.5–3.0 A*	2 – 6	GPP 18	·	·	·	1832656
1.0 – 35.0 Ah	1.6–4.0 A**	2 – 12	GPP 36	·	·	·	1834049

Switch-off criteria: TI = time, TG = T. grad, -DU = -Delta-U

\* without NTC 1.5 A  
\*\* without NTC 1.6 A

Output data					
Voltage	Current	Cells	Capacity	Housing	Order No.
6 V	900 mA	3	2.4 – 16.0 Ah	PP 8 EU	1890125
6 V	900 mA	3	2.4 – 16.0 Ah	PP 8 UK	1824106
6 V	900 mA	3	2.4 – 16.0 Ah	PP 8 US	1824107
6 V	1600 mA	3	4.8 – 32.0 Ah	MPP 15	1890126
6 V	3000 mA	3	9.0 – 60.0 Ah	MPP 30	1890129
12 V	500 mA	6	1.5 – 10.0 Ah	PP 8 EU	1824396
12 V	500 mA	6	1.5 – 10.0 Ah	PP 8 US	1825090
12 V	1000 mA	6	3.0 – 20.0 Ah	MPP 15	1890240
12 V	2000 mA	6	6.0 – 40.0 Ah	MPP 30	1890243
24 V	500 mA	12	1.5 – 10.0 Ah	MPP 15	1890241
24 V	1000 mA	12	3.0 – 20.0 Ah	MPP 30	1890130
24 V	1500 mA	12	4.5 – 30.0 Ah	MPP 30	1890222

Charge voltage can be adjusted for specific cell packs. Please observe battery specification.

# Accessories

## Primary adapters

The MPP/GPP line is available with country-specific mains plugs. The products are therefore universally applicable. Not only do the plugs enhance mobility and reliability of the corresponding product, they even facilitate the management of the country versions of power supplies and chargers.

In countries with other mains plug types, the IEC adapter with the 2-pin IEC 320 C8 socket provides a standardized alternative.

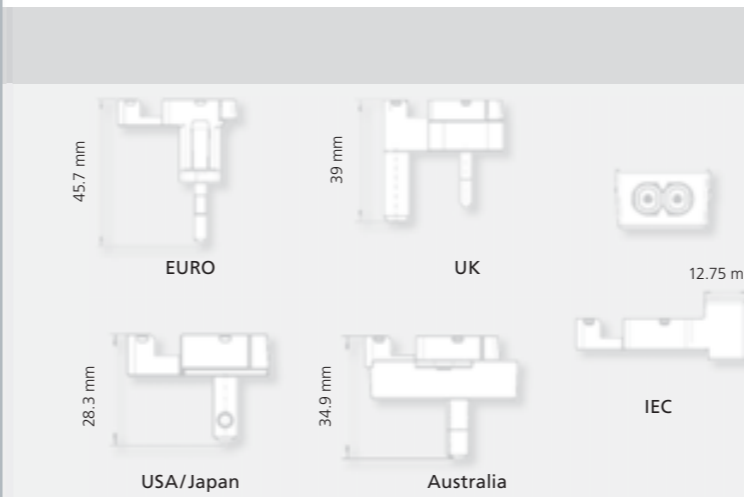

Primary adapter	GPP
Country	Order No.
<b>EURO</b>	<b>1827417</b>
<b>UK</b>	<b>1827420</b>
<b>USA/Japan</b>	<b>1827422</b>
<b>Australia</b>	<b>1827425</b>
<b>IEC</b>	<b>1827428</b>
<b>Korea</b>	<b>1835619</b>
<b>Argentina</b>	<b>1831610</b>
<b>India</b>	<b>1831323</b>
<b>China</b>	<b>1835620</b>
<b>Brazil</b>	<b>1835621</b>
<b>South Africa</b>	<b>1838236</b>

## Secondary adapters

All standard units come with a round lead of 1.83 m length and our approved secondary adapter system. Depending on the required output voltage, the wire diameter is between 0.25 mm<sup>2</sup> (AWG30) and 1,31 mm<sup>2</sup> (AWG16). FRIWO also offers a broad range of secondary output plugs, including coaxial plugs (acc. to DIN 45323) and jack plugs (acc. to DIN 45318). Polarity is adjustable by reversing connector.

Customer-specific leads are also an option. If necessary, customer-specific flat or round leads can be fitted. Special versions as well as types and dimensions of low voltage plugs are available too.

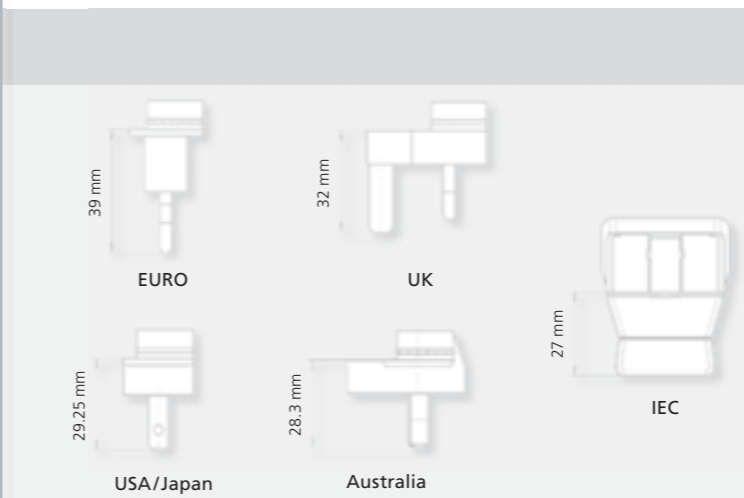
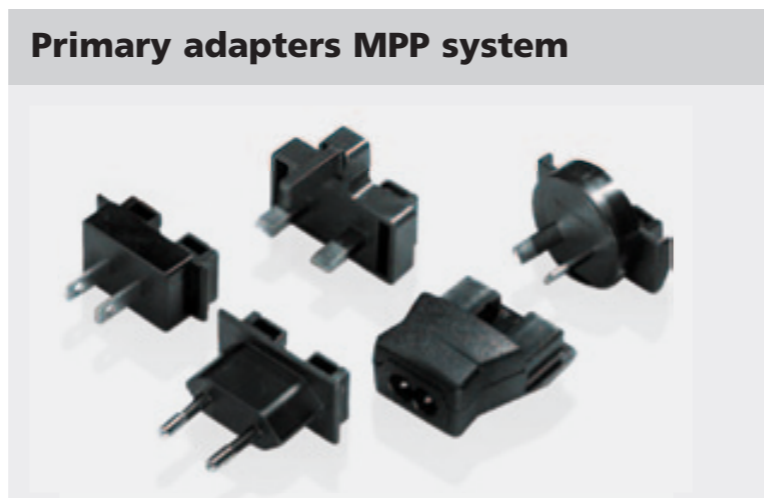

Primary adapter	MPP
Country	Order No.
<b>EURO</b>	<b>1717707</b>
<b>UK</b>	<b>1717618</b>
<b>USA/Japan</b>	<b>1717715</b>
<b>Australia MPP 15</b>	<b>1800496</b>
<b>Australia MPP 6/30</b>	<b>1804237</b>
<b>IEC</b>	<b>1809281</b>
<b>Korea</b>	<b>1832029</b>
<b>Brazil</b>	<b>1843164</b>
<b>China</b>	<b>1840406</b>

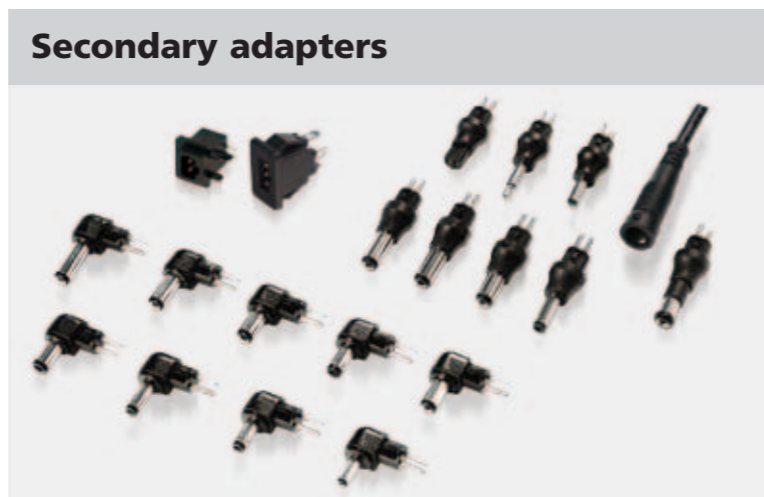

Straight coaxial connectors				Angled coaxial connectors			
Ø out.	Ø in.	Length mm	Order No.	Ø out.	Ø in.	Length mm	Order No.
3.5	1.3	9.5	1807699	3.5	1.3	9.5	1822478
4.0	1.7	9.5	1822557	4.0	1.7	9.5	1822558
4.0	1.7	11.0	1811994	4.0	1.7	11.0	1822482
4.8	1.7	9.5	1822559	4.8	1.7	9.5	1822560
5.5	2.1	9.5	1807700	5.5	2.1	9.5	1822479
5.5	2.1	11.5	1807701	5.5	2.1	11.5	1822480
5.5	2.1	14.0	1807697	5.5	2.1	14.0	1822476
5.5	2.5	9.5	1807698	5.5	2.5	9.5	1822477
5.5	2.5	11.5	1807702	5.5	2.5	11.5	1822481
5.5	3.3	9.5	1822561	5.5	3.3	9.5	1822562
<b>DIN 45323 1807703</b>				<b>DIN 45323 1822483</b>			

Straight jack connectors			Connectors/Sockets	
Ø out.	Length mm	Order No.	Description	Order No.
2.5	13	1807704	<b>Texas connector</b>	
3.5	14	1807705	<b>Straight Texas connector</b>	<b>1807706</b>
			<b>Angled Texas connector</b>	<b>1822486</b>
Angled jack connectors				
2.5	13	1822484	<b>Texas sockets 2-pin</b>	
3.5	14	1822485	<b>Snap in type</b>	<b>1323938</b>
			<b>PCB type</b>	<b>1321609</b>
			<b>Texas sockets 3-pin</b>	
			<b>Snap in type</b>	<b>1327259</b>
			<b>PCB type</b>	<b>1363506</b>

## Power cords

Power cords with 2 contact IEC 320 C7 mains plug provide a specific solution for each country. All power cords are 2 m of length and can be used with our IEC 320 CB socket for the MPP/GPP and DT lines.

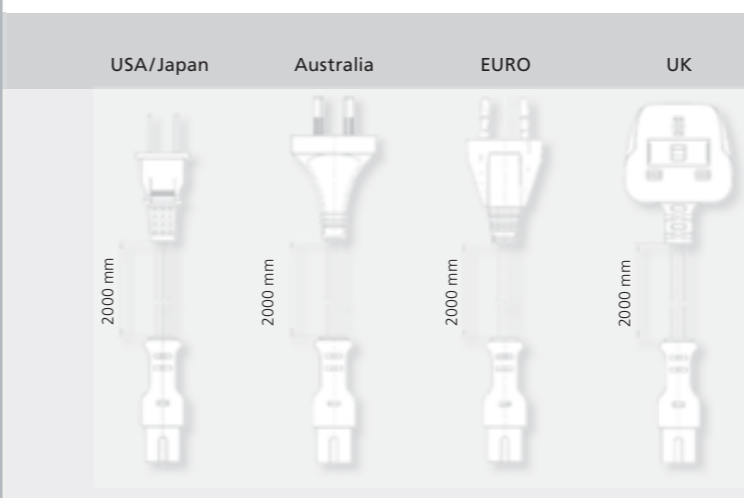
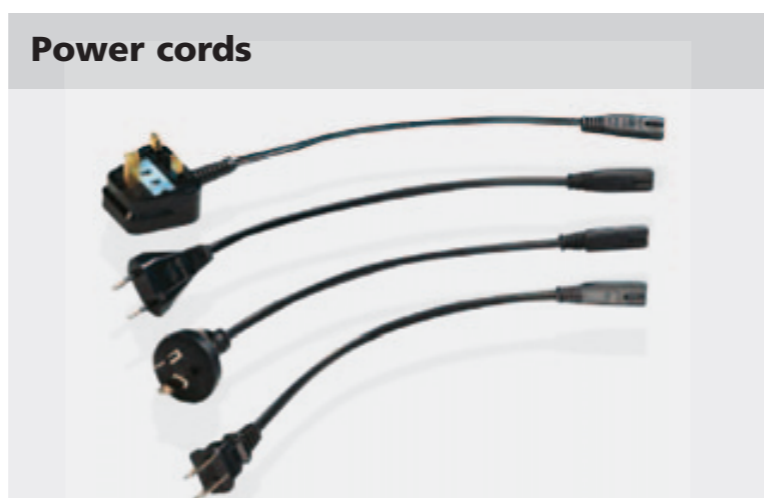

Power cords	
Country	Order No.
<b>EURO</b>	<b>1812274</b>
<b>UK</b>	<b>1812275</b>
<b>USA/Japan</b>	<b>1812276</b>
<b>Australia</b>	<b>1812277</b>
<b>China</b>	<b>1843276</b>



# LED Drivers Standard Range

All products comply with  
EN61347-1 and EN61347-2-13

## Applications

- Lighting

## Characteristics

- Voltage and current regulation within single design
- Compact design: 21 x 30 mm (LT 10 – LT 60), 24 x 30 mm (LT 100)
- Active PFC  $\geq$  LT 40
- Continuously short circuit proof
- Overload protection
- Overtemperature protection
- Fastening by screws, rivets, cable straps or clips...
- LED dimmable with DALI, 1-10V or Push-Dim via connectable DIMMbox
- IP rating: IP20, IP67 (LT-UP, LT 40 WP)

## Technical data

### Input voltage

100 to 120 V AC  
220 to 240 V AC

### Input current

150 mA (LT 10 UP), 200 mA (LT 20 UP),  
90 mA (LT 10), 200 mA (LT 20), 180 mA (LT 40)

### Frequency

50 to 60 Hz

### Efficiency

up to 91% typ. at full load

### EMC

Conforms to  
EN 55012, EN 61000-3-2, EN 62384, EN 61547

### Output voltage tolerance

$\pm 2\%$

### Environmental specification

**Operating temperature** -20 to +45°C at maximum load

**Storage temperature** -40 to +70°C

**Humidity** 5% to 90% non condensing

**Input transient susceptibility** Complies with IEC 61000 requirements

### Safety specification

#### Standards

Fulfills class II, SELV according to following standards:  
EN/IEC 61437-1, EN/IEC 61347-2-13

### Reliability specification

#### MTBF calculation

typ. 200,000 hours at maximum load and an ambient temperature of 25° C (in accordance with MIL-HDBK-217)

### Mechanical specification

#### Weight approx.

90 g (LT 10 UP), 125 g (LT 20 UP), 50 g (LT 10),  
82 g (LT 20), 106 g (LT 40)

#### Plug connector

connecting bracket 0.5..1.5 mm<sup>2</sup>

## LT Accessories



### LT SQ Cap

Order No. 1840704  
for LT 40 SQ, LT 60 SQ

### LT Cap

Order No. 1839772  
for LT 10, LT 20, LT 40, LT 60,  
LT 100 and DIMMbox

### LT Cap slim

Order No. 1844170  
for LT 10, LT 20, LT 40, LT 60,  
LT 100 and DIMMbox

## LT UP FW7804



## 10 / 20 Watts



## LT 10 LT 10



## 10 Watts



## LT 20 LT 20



## 20 Watts



## LT 40 LT 40



## 40 Watts

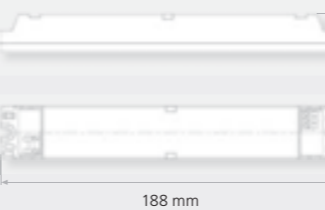

Model	Order No.	Output voltage*	Output current*
LT10-12 UP <sup>1</sup>	1896539	8-12 VDC	0-1000 mA
LT10-24 UP <sup>1</sup>	1896408	8-24 VDC	0-500 mA
LT10-36 UP <sup>1</sup>	1895582	8-37 VDC	0-350 mA
LT10-36/300 UP <sup>1</sup>	1897066	8-37 VDC	0-300 mA
LT20-24 UP <sup>1</sup>	1896409	12-24 VDC	0-850 mA
LT20-31 UP <sup>1</sup>	1895583	15-31 VDC	0-700 mA
LT20-36/600 UP <sup>1</sup>	1897067	15-37 VDC	0-600 mA

<sup>1</sup>without DIMMbox connection

Model	Order No.	Output voltage*	Output current*
LT10-12 <sup>1</sup>	1895611	1-12 VDC	3-700 mA
LT10-16 <sup>1</sup>	1895089	1-16 VDC	3-700 mA
LT10-24 <sup>1</sup>	1896009	1-24 VDC	3-550 mA
LT10-32 <sup>1</sup>	1895008	2-32 VDC	3-350 mA
LT10-32 DB	1895541	8-32 VDC	3-350 mA
LT10-36/300 <sup>1</sup>	1897064	8-37 VDC	0-300 mA

<sup>1</sup>without DIMMbox connection

Model	Order No.	Output voltage*	Output current*
LT20-24	1894910	15-24 VDC	0-833 mA
LT20-28	1894611	5-28 VDC	350-700 mA
LT20-28/700 1-10V	1897012	5-28 VDC	350-700 mA
LT20-36/600	1897065	15-37 VDC	0-600 mA
LT20-40	1895718	15-40 VDC	0-450 mA
LT20-40	1894612	10-40 VDC	200-500 mA
LT20-40/500 1-10V	1897014	10-40 VDC	200-500 mA
LT20-48	1895720	15-48 VDC	0-200 mA
LT20-48	1894613	15-48 VDC	100-350 mA
LT20-48	1895013	15-48 VDC	0-417 mA
LT20-48/350 1-10V	1897015	15-48 VDC	100-350 mA

Model	Order No.	Output voltage*	Output current*
LT40-24	1894614	10-24 VDC	700-1.400 mA
LT40-24	1894973	10-24 VDC	700-1.460 mA
LT40-24/1400 1-10V	1897016	10-24 VDC	700-1400 mA
LT40-27	1895641	17-27 VDC	0-1.150 mA
LT40-36	1894615	15-36 VDC	500-1.050 mA
LT40-36/900	1897068	15-37 VDC	0-900 mA
LT40-36/1050 1-10V	1897017	15-36 VDC	500-1050 mA
LT40-48	1894616	22-48 VDC	350-700 mA
LT40-48 1-10 V	1896700	22-47 VDC	0-700 mA

\* Standard units will be delivered with highest voltage and current output.

# LED Drivers Standard Range

All products comply with  
EN61347-1 and EN61347-2-13

## Applications

- Lighting

## Characteristics

- Voltage and current regulation within single design
- Compact design: 21 x 30 mm (LT 10 – LT 60), 24 x 30 mm (LT 100)
- Active PFC  $\geq$  LT 40
- Continuously short circuit proof
- Overload protection
- Overtemperature protection
- Fastening by screws, rivets, cable straps or clips...
- LED dimmable with DALI, 1-10V or Push-Dim via connectable DIMMbox
- IP rating: IP20, IP67 (LT-UP, LT 40 WP)

## Technical data

### Input voltage

100 to 120 V AC  
220 to 240 V AC

### Input current

180 mA (LT 40 WP), 300 mA (LT 60),  
450 mA (LT 60 SQ), 700 mA (LT 60 SQ US)

### Frequency

50 to 60 Hz

### Efficiency

up to 91% typ. at full load

### EMC

Conforms to  
EN 55012, EN 61000-3-2, EN 62384, EN 61547

### Output voltage tolerance

$\pm 2\%$

### Environmental specification

**Operating temperature** -20 to +45°C at maximum load

**Storage temperature** -40 to +70°C

**Humidity** 5% to 90% non condensing

**Input transient susceptibility** Complies with IEC 61000 requirements

### Safety specification

#### Standards

Fulfils class II, SELV according to following standards:  
EN/IEC 61437-1, EN/IEC 61347-2-13

### Reliability specification

#### MTBF calculation

typ. 200,000 hours at maximum load and an ambient temperature of 25° C (in accordance with MIL-HDBK-217)

### Mechanical specification

#### Weight approx.

200 g (LT 40 WP), 130 g (LT 60),  
150 g (LT 60 SQ), 160 g (LT 60 SQ US)  
connecting bracket 0.5..1.5 mm<sup>2</sup>

#### Plug connector

## LT Accessories



### LT SQ Cap

Order No. 1840704  
for LT 40 SQ, LT 60 SQ

### LT Cap

Order No. 1839772  
for LT 10, LT 20, LT 40, LT 60,  
LT 100 and DIMMbox

### LT Cap slim

Order No. 1844170  
for LT 10, LT 20, LT 40, LT 60,  
LT 100 and DIMMbox

## LT 40 WP LT 40 WP



40 Watts

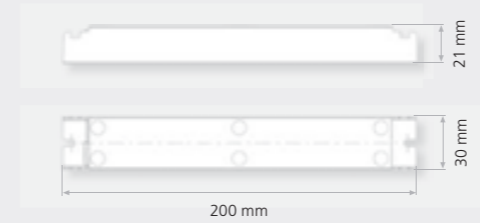

## LT 40 SQ LT 40 SQ



40 Watts

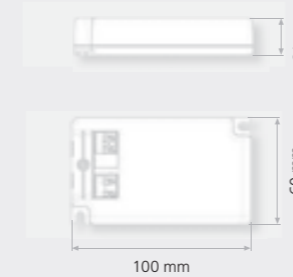

## LT 60 LT 60



60 Watts

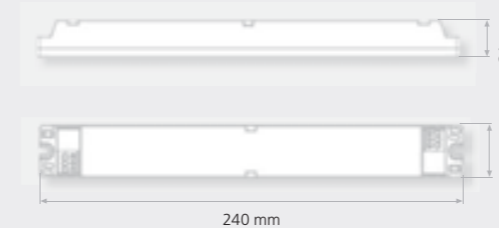

## LT 60 SQ LT 60 SQ



60 Watts



Model	Order No.	Output voltage*	Output current*
LT40-24 WP <sup>1</sup>	1894660	10-24 VDC	700-1.400 mA
LT40-36 WP <sup>1</sup>	1894661	15-36 VDC	500-1.050 mA
LT40-48 WP <sup>1</sup>	1894662	22-48 VDC	350-700 mA

<sup>1</sup>without DIMMbox connection

Model	Order No.	Output voltage*	Output current*
LT40-24 SQ	1895925	10-24 VDC	700-1.400 mA
LT40-36 SQ	1896077	15-36 VDC	500-1.050 mA
LT40-48 SQ	1896078	22-48 VDC	350-700 mA

Model	Order No.	Output voltage*	Output current*
LT60-24	1894681	15-24 VDC	0-2500 mA
LT60-36	1895136	22-36 VDC	0-1600 mA
LT60-36	1897069	22-37 VDC	0-1200 mA
LT60-36	1897071	22-37 VDC	0-1500 mA
LT60-48	1895106	30-48 VDC	0-1200 mA
LT60-24 1-10 V WR <sup>1</sup>	1895553	24 VDC	0-2500 mA
LT60-85 1-10 V	1896459	40-85 VDC	0-700 mA
LT60-170 1-10 V	1896458	100-170 VDC	0-350 mA

<sup>1</sup>wide range input 100-240 V AC, LT 100 housing

Model	Order No.	Output voltage*	Output current*
LT60-24 SQ	1895735	15-24 VDC	0-2500 mA
LT60-36 SQ	1895373	22-36 VDC	0-1600 mA
LT60-36 SQ	1897070	22-37 VDC	0-1200 mA
LT60-36 SQ	1897072	22-37 VDC	0-1500 mA
LT60-36 SQ US	1897073	22-37 VDC	0-1200 mA
LT60-36 SQ US	1897074	22-37 VDC	0-1500 mA
LT60-48 SQ	1895950	30-48 VDC	0-1200 mA

\* Standard units will be delivered with highest voltage and current output.

# LED Drivers Standard Range

All products comply with  
EN61347-1 and EN61347-2-13

## Applications

- Lighting

## Characteristics

- Voltage and current regulation within single design
- Compact design: 21 x 30 mm (LT 10 – LT 60), 24 x 30 mm (LT 100)
- Active PFC  $\geq$  LT 40
- Continuously short circuit proof
- Overload protection
- Overtemperature protection
- Fastening by screws, rivets, cable straps or clips...
- LED dimmable with DALI, 1-10V or Push-Dim via connectable DIMMbox
- IP rating: IP20, IP67 (LT-UP, LT 40 WP)

## Technical data

### Input voltage

100 to 120 V AC  
220 to 240 V AC

### Input current

325 to 300 mA (LT 60 DPA), 480 mA (LT 100),  
0 to 5A (DIMMbox)

### Frequency

50 to 60 Hz

### Efficiency

up to 91% typ. at full load

### EMC

Conforms to  
EN 55012, EN 61000-3-2, EN 62384, EN 61547

### Output voltage tolerance

$\pm 2\%$

### Environmental specification

#### Operating temperature

-20 to +45°C at maximum load

#### Storage temperature

-40 to +70°C

#### Humidity

5% to 90% non condensing

#### Input transient susceptibility

Complies with IEC 61000 requirements

### Safety specification

#### Standards

Fulfills class II, SELV according to  
following standards:  
EN/IEC 61437-1, EN/IEC 61347-2-13

### Reliability specification

#### MTBF calculation

typ. 200,000 hours at maximum load  
and an ambient temperature of 25° C  
(in accordance with MIL-HDBK-217)

### Mechanical specification

#### Weight approx.

200 g (LT 40 WP), 130 g (LT 60),  
150 g (LT 60 SQ), 160 g (LT 60 SQ US)  
connecting bracket 0.5..1.5 mm<sup>2</sup>

#### Plug connector

## LT 60 DPA LT 60 DPA



60 Watts

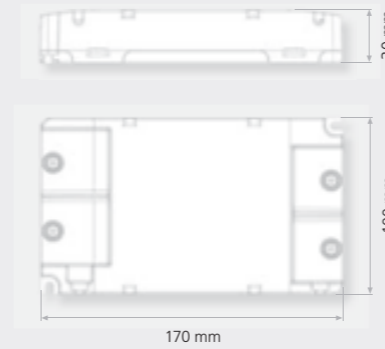

## LT 100 LT 100



100 Watts

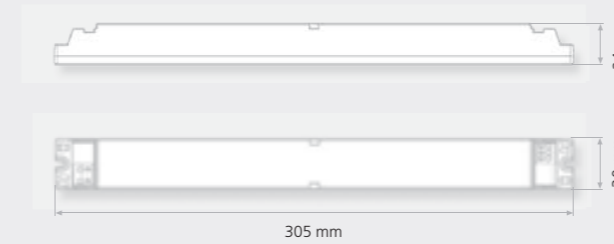

## DIMMbox DIMMbox



## LS 12 – Light Control LS 12

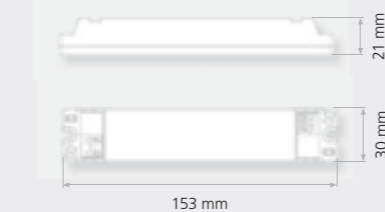

Model	Order No.	Output voltage*	Output current*
LT60 DPA	1895499	18–42 VDC	350–1.400 mA

Output current adjustable by customer  
incl. DALI, Push-Dim and 1-10V

Model	Order No.	Output voltage*	Output current*
LT100-24	1894680	15–24 VDC	0–4.200 mA
LT100-36	1896218	22–36 VDC	0–2.800 mA
LT100-48	1896207	30–48 VDC	0–2.100 mA
LT100-285 1-10V	1896460	190–285 VDC	0–350 mA
LT100-142 1-10V	1896461	100–142 VDC	0–700 mA

Model	Order No.	Output voltage*	Output current*
DIMMbox	1894848	15–50 VDC	5.000 mA
DIMMbox 1-10 OFF	1896084	15–50 VDC	5.000 mA
DIMMbox CV	1897004	15–50 VDC	5.000 mA

**Functional description**  
The DIMMbox and the connected LED(s) are powered by the power supply/ LED driver at the input of the DIMMbox.  
The dimming function is achieved by pulse width modulation control (PWM) at the LED minus output. Switching frequency is around 600Hz.  
DIMMbox: control range 10 – 100 %  
DIMMbox 1-10 OFF: control range 10 – 100 %, at an interface voltage between 1 – 10 V/ $< 0,7$  V = off  
DIMMbox CV: control range 1 – 100 %, at an interface voltage between 1 – 10 V

Model	Order No.	Output voltage*	Output current*
LS12/100 DPA	1895885	13 $\pm$ 1 VDC	100 mA

**Functional description**  
The light control is a converter for light control signals. An extended 1 – 10 V interface serves as output. For input DALI, PUSH-DIM, a PWM signal or a 1 – 10 V dimmer can be chosen.  
The output is synchronized with the FRIWO LED drivers and their integrated 1 – 10 V interface.

## LT Accessories



### LT SQ Cap

Order No. 1840704  
for LT 40 SQ, LT 60 SQ

### LT Cap

Order No. 1839772  
for LT 10, LT 20, LT 40, LT 60,  
LT 100 and DIMMbox

### LT Cap slim

Order No. 1844170  
for LT 10, LT 20, LT 40, LT 60,  
LT 100 and DIMMbox

\* Standard units will be delivered with highest voltage and current output.

# E<sup>2</sup>MS Excellence in Engineering & Electronic Manufacturing Services



FRIWO is your competent partner for the implementation and development of visions and ideas up to series production of your electronic systems. From PCB assembly, production of entire units and worldwide shipping – with E<sup>2</sup>MS FRIWO offers a service platform that allows you to focus on your core business and competencies.

We support you throughout the entire value chain: from engineering and prototyping through purchasing and manufacturing and ultimately approval assistance.

FRIWO's lead and competence factory Ostbevern, certified in accordance with DIN EN ISO 9001 and TS 16949, handles the initial production of products by means of modern manufacturing processes (auto assembly, AOI, selective soldering, X-ray, etc...).



Short distances between R&D and production allow innovative production techniques and streamlined processes, which can also be pursued and implemented after a subsequent shift to our global manufacturing locations. This leads to short lead times and consistently high quality, enabling us to support you in accelerating the market introduction of your products.

In case of unplanned or unexpected market developments we are able to respond flexibly with our fast-line production.

Through constant follow-up and continuous improvement of process technology in all areas of manufacturing, we ensure high quality at optimized costs and maximize your business success in the market.



## Quality in good hands:

**Manufacturing**

Contract manufacturing of electronic systems and PCBs in form of sheer servicing.

**Services**

- Global purchasing of PCBs and components
- Design and implementation of testing concepts
- Logistics and global distribution

**2nd Source**

- Manufacturing of excess demands
- Quota management
- Avoidance of dependencies

**Engineering**

Setup of concept and specification

Setup of requirement specification

Acceptance of defined R&D services

Project management

General entrepreneurship, exploration and coordination of external engineering partners for special requirements, i.e. explosion protection

EMC level optimization and harmonization

Support for certification and approval

**Systems & Processes**

Definition and capture of requirements

Acceptance of system engineering services

Design, specification and implementation of production processes for projects and systems



**FRIWO E<sup>2</sup>MS**

Short routes, same time zone,  
same language – quick response  
= quality in good hands

**E2MS@friwo.de**

# Glossary

Battery type	Lead Acid	NiCd	NiMH	Li-Ion cobalt manganese	LiFePO <sub>4</sub>
Cell voltage	2.0 V	1.2 V	1.2 V	3.6 resp. 3.7 V	3.3 V
Energy density [Wh/kg]	30–50	45–80	60–120	110–190 110–120	90–130
Self-discharge ratio per month	5%	20%	30%	2–5%	2–5%
Overload tolerance	high	moderate	low	very low	very low
Charging cycles	200–400	1500	300–500	300–500	1000–2000
Charging method	U = const.	I = const.	I = const.	300–500	U = const.
Charging characteristic	IU0U, IU1a	I0I	I0I	IUa	IUa
	Phase 1: constant current	Charging criteria: -dV, dT/dt, dU/dt, T <sub>max</sub>		Phase 1: constant current	Phase 1: constant current
	Phase 2: constant voltage	Identification and control via microcontroller		Phase 2: constant voltage ± 1 % tolerance	Phase 2: constant voltage ± 1 % tolerance
	Phase 3: trickle charge				

## Abbreviations

CPP	= Customized Power Plug
DT	= Desktop
E <sup>2</sup> MS	= Engineering & Electronic Manufacturing Services
GPP	= Global Power Plug
LED	= Light Emitting Diode
LT	= LED Driver
MPP	= Multi Power Plug
OF	= Open frame
PP	= Power Plug
SMT	= Surface Mount Technology
UP	= In-wall
USB	= Universal Serial Bus

## Cell chemistries

Li-Ion	= Lithium Ion
LiFePO <sub>4</sub>	= Lithium Iron Phosphate
NiCd	= Nickel Cadmium
NiMH	= Nickel Metal Hydride
Pb	= Lead Acid

## Ambient temperature

Temperature of inactive air which surrounds the power supply. It is usually measured approx. 10 mm apart from the running power supply.

## Class B

Protection against electric shock in due consideration of the leakage current.

## Class BF

Like B, but taking into account the so-called „F parts“ which may accidentally come into contact with the patient and which are isolated from other parts.

## Class CF

Class with the highest protection.

## Current limited

Electronic overload protection which limits the maximum output current to a preset value.

## Efficiency

Efficiency is calculated as the ratio of output to input power and is always smaller than 1. To reduce the power loss under the given load prerequisites, the maximum efficiency ratio is aspired. For a power supply it is measured at full load and at nominal input. The difference between input and output is transposed into heat, hence each increase of the efficiency ratio means less thermal stress on the components and therefore a life-cycle increase. Even a minor improvement of the efficiency ratio can have a dramatic impact on the life-cycle.

Standards	Office/IT	Medical	Tools, chargers, toys, household appliances	EMC	Surge	Burst
EU	EN60950-1	EN60601-1	EN60335-1	EN61000/EN55014	EN61000-4-4	EN61000-4-5
USA	UL60950-1	UL60601-1	UL 1310/E60335/UL 697	FCC 47 part 15/EN61000	EN61000-4-4	EN61000-4-5
Canada	C22.2 No. 60950-1	C22.2 No. 60601.1-M90	C22.2 No.223-M91 C22.2 No.173-M1983 (Toys)	FCC 47 part 15/EN61000	EN61000-4-4	EN61000-4-5
China	GB4943	GB9706.1	GB4706	GB4343.1	GB/T17626.4	GB/T17626.5

## EMC

The ability of electrical equipment to function satisfactorily in its electromagnetic environment without negative interferences. Power supplies should meet at least two generic standards for EMC:

1. standard for transient emissions (grid-bound interferences emitted by the power supply) and
2. standard for interference immunity (protection against external interferences)

These generic standards comprise a multitude of sub-standards that define threshold values for subdomains (for example certain types of interferences). FRIWO power supplies meet these standards to a higher degree than required to make the most of EMC, and to safeguard a trouble-free service.

## Life-cycle

Life-cycle of a power supply. After the end of life power supplies are likely to break down because of worn components.

## NTC

A temperature-sensitive resistor with negative coefficient which reduces the resistance as temperature increases. It is therefore also called thermistor. It serves not only the temperature monitoring but also limits the inrush current of power supplies.

## Operating temperature

Temperature of still air surrounding the device. It is usually measured approx. 10 mm next to the operated device.

## Overvoltage resistance

A circuitry within the power supplies monitors the output. If a preset threshold value is exceeded, the power supply will be turned off.

## Short circuit proof

Short circuit proof means that a temporary short circuit can be absorbed without damage.

## Single range

Power supplies with single input voltage for the use in the respective countries.

## SMT

SMT is a surface mount technology which allows surface mountable components with solderable pads (without wire connectors) to be soldered directly onto a PCB.

## Standby losses

Power consumption of a power supply during idle service.

## Storage temperature

Temperature range in which a device may be stored (not operated) without being damaged.

## Sustained short circuit proof

A short circuit might occur without damaging the output. As soon as the problem is solved, the output will return to normal service.

## THT

Stands for „through-hole technology“. Wired components are connected to the PCB by vias and connected by a special THT soldering process.

## Voltage controlled

A control loop in the power supply stabilizes the output voltage, independent of all factors (e.g. temperature).

## Wide range

Power supplies with wide range input can be operated at different nominal voltages without having to be adjusted (manually or automatically).





# FRIWO worldwide

## Europe Germany

### FRIWO Gerätebau GmbH

P.O. Box 1164  
Von-Liebig-Strasse 11  
D-48346 Ostbevern  
Tel.: +49 25 32 81 - 0  
Fax: +49 25 32 81 - 112  
sales@friwo.de  
www.friwo.de

## Asia China

### FRIWO Power Solutions

Technology (ShenZhen) Co. Ltd.  
B1 Building, 3rd XinAn Industrial Zone  
HangCheng Industrial Zone, XiXiang  
BaoAn District, ShenZhen, P.R. China  
Postcode: 518102  
Tel.: +86 755 33 25 58 88  
Fax: +86 755 33 26 02 69  
sales.asia@friwo.com.cn  
www.friwo.com

### FRIWO Shanghai

Rm. 601, Bldg. No. 1,  
RongBo Commercial Bldg.  
No. 335 XianXia Rd.,  
ChangNing District,  
Shanghai  
Postcode: 200051  
Tel.: +86 21 62 35 01 21  
Fax: +86 21 62 35 02 89  
sales.asia@friwo.com.cn  
www.friwo.com

## Asia Japan

### FRIWO Japan branch

Masuni Dai-ichi Building, 6F  
4-6, Shinyokohama, 2-chome, Kohoku-ku,  
Yokohama-shi, Kanagawa 222-0033  
Japan  
Tel.: +81 45 470 - 02 06  
Fax: +81 45 470 - 02 07  
friwojp@friwojp.com  
www.friwo.com

## Distributors Europe

### Austria

**Kellner Netcom GmbH**  
Siemensstrasse 28  
70825 Korntal-Münchingen  
Tel.: +49 71 50 9 13 16 - 34  
Fax: +49 71 50 9 13 16 - 44  
friwo@kellner-netcom.de  
www.kellner-netcom.de

### Belgium

**Alcom electronics NV/SA**  
Singel 3  
2550 Kontich  
Tel.: +32 3-458 30 33  
Fax: +32 3-458 31 26  
info@alcom.be  
www.alcom.eu

### Finland

**Oy Flinkenberg Ab**  
PL 69 (Mikkellänkallio 3)  
02771 Espoo, Finland  
Tel.: +358 9 859 911  
Fax: +358 9 8599 1306  
electronics@flinkenberg.fi  
www.flinkenberg.fi

### France

**CATS S. A.**  
19 avenue de Norvège - BP342  
Villebon Sur Yvette  
91958 Courtabœuf cedex  
Tel.: +33 1 69 59 21 54  
Fax: +33 1 69 59 21 51  
friwo.cats@fr.oleane.com  
www.cats-france.fr

### Germany

**Hubert Schroeter KG (Agency)**  
**Schroeter electronic Handels-**  
**gesellschaft mbH (Distribution)**  
Saseler Bogen 1  
22393 Hamburg  
Tel.: +49 40 60 00 06 - 0  
Fax: +49 40 60 00 06 - 30  
info@schroeter-kg.de  
www.schroeter-kg.de  
info@schroeter-electronic-gmbh.de  
www.schroeter-electronic-gmbh.de

### Kellner Netcom GmbH

Siemensstrasse 28  
70825 Korntal-Münchingen  
Tel.: +49 71 50 9 13 16 - 34  
Fax: +49 71 50 9 13 16 - 44  
friwo@kellner-netcom.de  
www.kellner-netcom.de

### Ireland

**Eltech Ltd.**  
Rubicon Centre  
CIT Campus  
Bishopstown  
Cork  
Tel.: +353 86 255 66 50  
eltech@iol.ie  
www.friwo.com

### Israel

**Tamuz Electronics Ltd.**  
3 Hayozma St. Industrial Zone  
Kfar-Saba 44422 Israel  
P.O Box 7124, Kfar-Saba 44641 Israel  
Tel.: +972 9 76 33 000  
Fax: +972 9 76 33 011  
info@tamuz-ele.co.il  
www.tamuz-ele.co.il

### Italy

**ELSAP SPA**  
Viale Famagosta, 61  
20142 Milano  
Tel.: +39 02 89 12 52 72  
Fax: +39 02 89 12 53 04  
fbenedetti@elsap.it  
www.elsap.it

### Netherlands

**Alcom Electronics B.V.**  
Rivium 1e straat 52  
2909 LE Capelle a/d IJssel  
Tel.: +31 10-288 25 00  
Fax: +31 10-288 25 25  
info@alcom.nl  
www.alcom.eu

### Poland

**Elhurt Spółka z o.o.**  
ul. Galaktyczna 35A  
80-299 Gdańsk  
Tel.: +48 58 554 0800  
Fax: +48 58 554 0807  
elhurt@elhurt.com.pl  
www.elhurt.com.pl

### Russia

**ELTECH SPb**  
10/6 Dvinskaya str.  
198035 Saint-Petersburg  
Tel.: +7 812 635 50 60  
Fax: +7 812 635 50 70  
ekaterina.vasilieva@eltech.spb.ru  
www.eltech.spb.ru

### Scandinavia

**AWILCO-MULTIPLEX**  
Yderholmvej 64  
4623 Lille Skensved  
Tel.: Denmark: +45 56 56 55 00  
Tel.: Sweden: +46 8 59 08 05 74  
Fax: +45 56 56 55 05  
mail@awilco-multiplex.dk  
www.awilco-multiplex.dk

### Slovakia, Hungary, Czechia, Romania

**SOS electronic s.r.o.**  
Pri prachárni 16  
040 11 Košice  
Slovensko  
Tel.: +421 55 / 786 04 15  
Fax: +421 55 / 786 04 45  
info@sos.sk  
www.soselectronic.sk

### Slovenia

**IC Elektronika d.o.o.**  
Vodovodna cesta 100  
1001 Ljubljana  
Tel.: +386 15 68 01 33  
Fax: +386 15 68 91 07  
primoz.strajnar@ic-elect.si  
www.ic-elect.si

### Spain /Portugal

**Matrix Electrónica, S.L.**  
C/Alejandro Sanchez, 109  
28019 Madrid - Spain  
Tel.: +34 91 56 02 737  
Fax: +34 91 56 28 65  
matrix@matrix.es  
www.matrix.es

### Switzerland

**NOVITRONIC AG**  
Thurgauerstrasse 74  
8050 Zürich  
Tel.: +41 44 306 91 73  
Fax: +41 44 306 91 03  
energietechnik@novitronic.ch  
www.novitronic.ch

### Turkey

**RADEL ELEKTRONİK DIŞ TİCARET**  
**VE SANAYİ A.Ş.**  
Necatibey Cadessi No. 81  
Karaköy / Istanbul  
Tel.: +90 21 22 93 84 16  
Fax: +90 21 22 93 74 43  
arisy@superonline.com

### United Kingdom

**Haredata Electronics**  
Unit 6 Stoneacres,  
Grimbald Crag Close,  
St. James Business Park  
Knaresborough, HG 5 8PJ  
Tel.: +44 14 23 79 62 40  
Fax: +44 14 23 79 62 49  
sales@haredata.co.uk  
www.haredata.co.uk

## Distributors North America

### USA

**PEI-Genesis**  
2180 Hornig Road  
Philadelphia, PA 19116  
Tel.: + 1 888 887-9017 USA/Canada  
Tel.: + 1 215 673-0400 outside USA/  
Canada  
Fax: + 1 215 638-8360  
phsales@peigenesis.com  
www.peigenesis.com

### Components Center

11208 Young River  
Fountain Valley, CA 92708  
Tel.: + 1 800 598 - 04 33  
Fax: + 1 714 557 - 73 90  
e-sales@componentscenter.com  
www.componentscenter.com

### Dalis Electronics

3645 East Atlanta Avenue  
Phoenix, AZ 85040  
Tel.: + 1 800 888 - 14 08  
Fax: + 1 602 275 - 05 78  
e-sales@componentscenter.com  
www.componentscenter.com

### Future Electronics

237 Hymus Blvd.  
Pointe-Claire, Quebec H9R 50  
Tel.: + 1 514 694 - 77 10  
Fax: + 1 514 695 - 37 07  
eService@futureelectronics.com  
www.futureelectronics.com

### Components Center

3351 Edward Avenue  
Santa Clara, CA 95054  
Tel.: + 1 800 776 - 08 10  
Fax: + 1 408 988 - 69 31  
e-sales@componentscenter.com  
www.componentscenter.com

### Vale Distribution

2 Linda Lane, Suite B  
Vincentown, NJ 08088  
Tel.: + 1 800 606 - 82 53  
Fax: + 1 609 859 - 87 59  
alan@valedistro.com  
www.valedistro.com

[www.friwo.de](http://www.friwo.de)

**EN** - For pricing and availability in your local country please visit one of the below links:

**DE** - Informationen zu Preisen und Verfügbarkeit in Ihrem Land erhalten Sie über die unten aufgeführten Links:

**FR** - Pour connaître les tarifs et la disponibilité dans votre pays, cliquez sur l'un des liens suivants:

[FW7713/13 \( BLACK \)](#)

**EN**

This Datasheet is presented by  
the manufacturer

**DE**

Dieses Datenblatt wird vom  
Hersteller bereitgestellt

**FR**

Cette fiche technique est  
présentée par le fabricant