

### ● Features:

1. Constant current supply: 320mA (at 36 V DC, max.)
2. Input power: 10 W.
3. Chip material: InGaN.
4. Emitted color: White.
5. High lumen output.
6. High light output efficiency (lm/w).
7. Excellent thermal management: Self-mounted on Al MCPCB.
8. Easy to be assemblies with heat sink.
9. Long life ( if the temperature of the Al MCPCB (Tb) is kept under 50°C , by using a suitable heat sink).
10. As a lighting board install, the prepared components bag should be applied. Avoiding the short damage of electrical circuit, insulating washers are required to apply. Please refer to the components assembling demonstration in Page 4.
11. This product do not contain restricted substance, compliance to ROHS standard.

### ● Applications:

1. Outdoor Lightings: street light, tunnel light.
2. Indoor Lightings: Recessed can light, suspension ceiling light, wall light.

### ● Package dimensions :

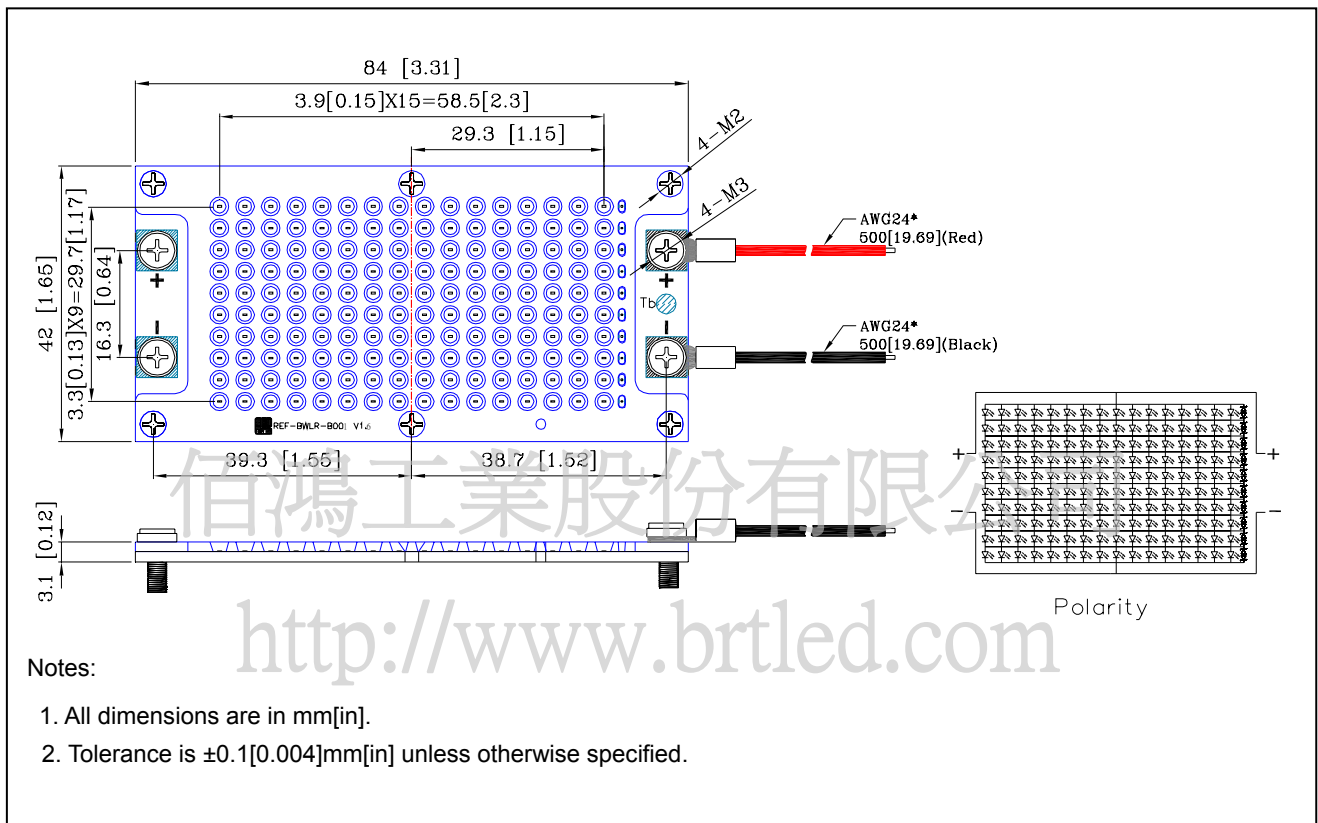

● Absolute maximum ratings

Parameter	Symbol	Rating	Unit
DC Input Forward Current *	$I_{IN}$	320	mA
Power Dissipation	$P_D$	10	W
Reverse input voltage	$V_r$	36	V DC
ESD	HBM	2000	V
Storage Temperature	$T_{stg}$	-40~80	°C
Temperature of Al MCPCB	$T_b$	70	°C

\* Proper current derating must be followed to keep the temperature of Al MCPCB( $T_b$ ) below 70°C.

● Electrical & Optical Characteristics ( $T_b=25^\circ\text{C}$ )

Parameter	Symbol	Condition	Min.	Typ.	Max.	Unit
Forward Voltage*	$V_F$	$I_F = 320\text{mA}$	-	-	36	V
Total Flux	$\Phi_v$	$I_F = 320\text{mA}$	-	800	-	lm
Light Efficient	$\eta$	$I_F = 320\text{mA}$	-	80	-	lm/W
Color Temperature	CCT	$I_F = 320\text{mA}$	4746	-	5310	K
Color Rendering Index	CRI	$I_F = 320\text{mA}$	-	70	-	
Viewing Angle	$2\theta_{1/2}$	$I_F = 320\text{mA}$	-	120	-	degree
Life Time	t	at $T_b \leq 50^\circ\text{C}$	-	30,000	-	hrs

\* A power supply with maximum constant current source of 320mA is highly recommended.

佰鴻工業股份有限公司

<http://www.brtled.com>

● Typical electro-optical characteristics curves

Fig.1 RELATIVE INTENSITY VS. WAVELENGTH

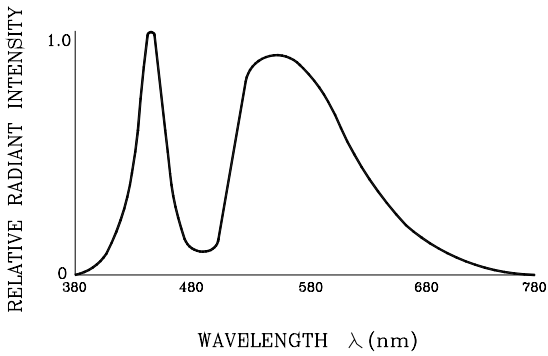

Fig.2 FORWARD CURRENT VS. AMBIENT TEMPERATURE

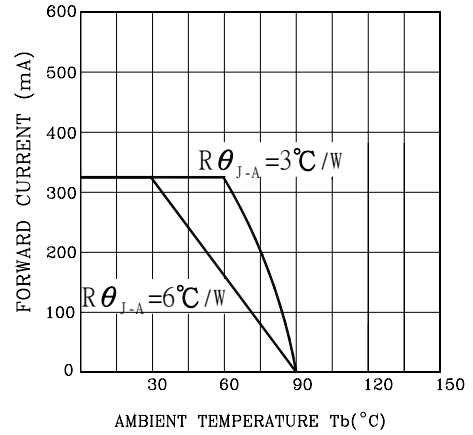

Fig.3 FORWARD CURRENT VS. FORWARD VOLTAGE

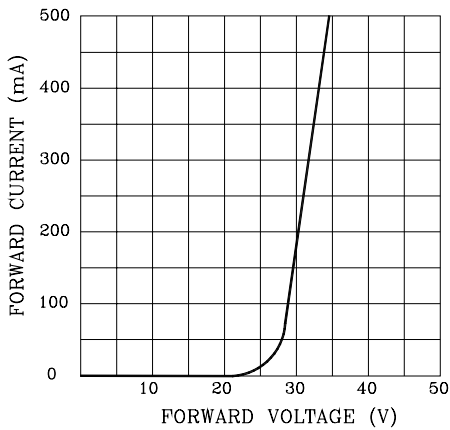

Fig.4 RELATIVE LUMINOUS INTENSITY VS. JUNCTION TEMPERATURE

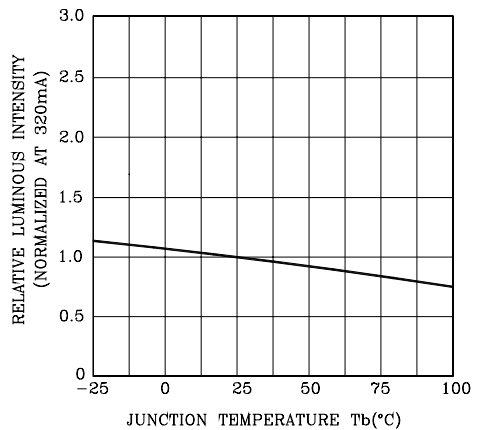

Fig.5 RELATIVE LUMINOUS INTENSITY VS. FORWARD CURRENT

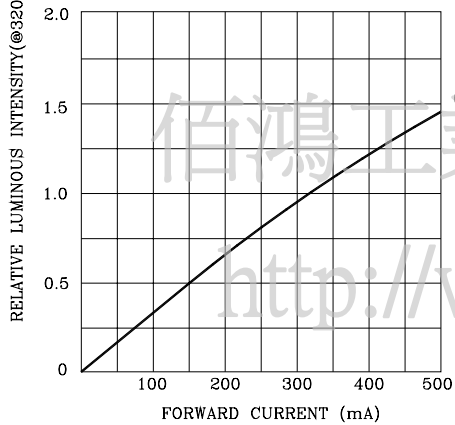
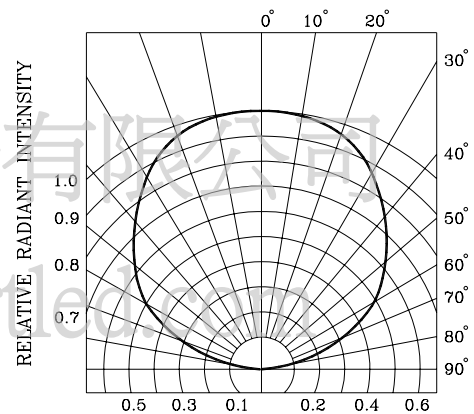
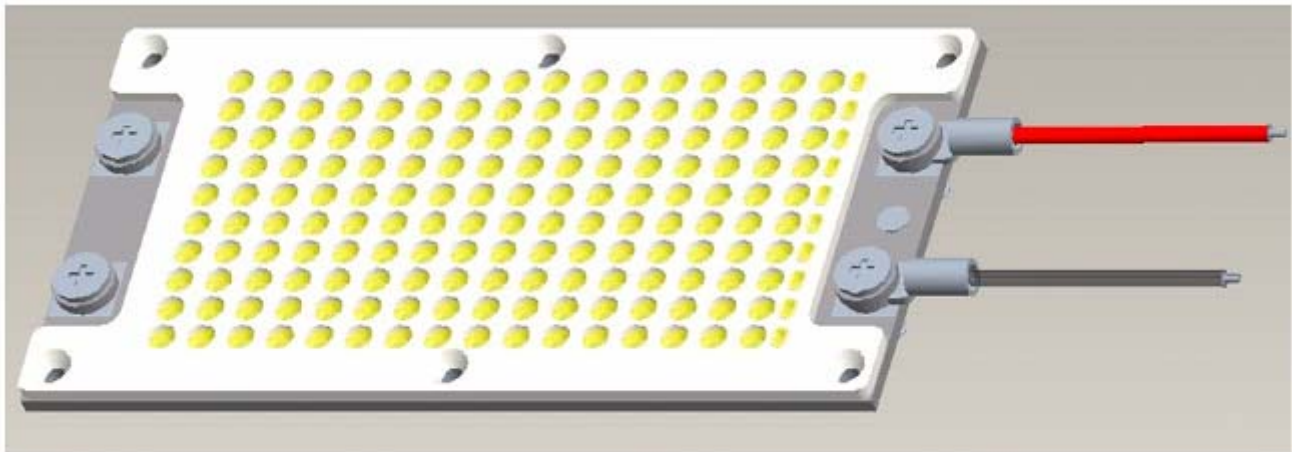
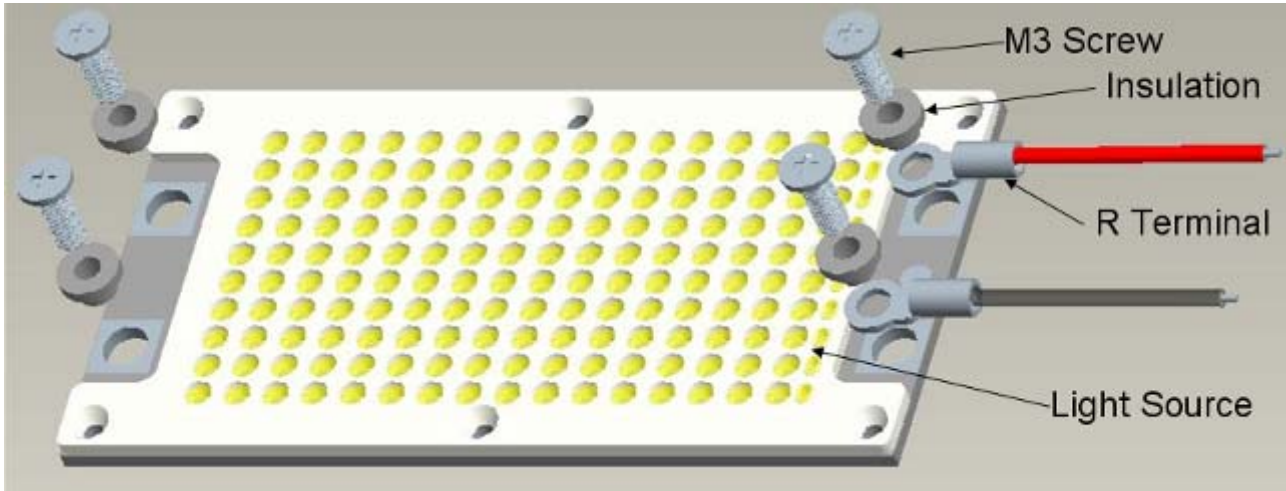

Fig.6 RADIATION DIAGRAM





● Components Assembling Demonstration :



佰鴻工業股份有限公司

<http://www.brtled.com>

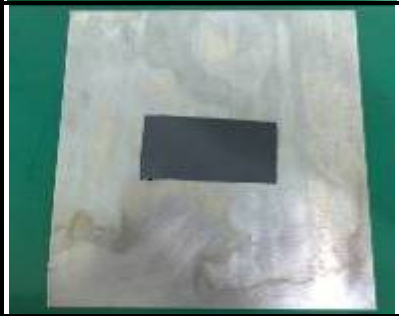
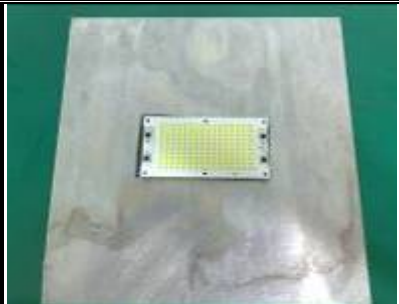
● Components Assembling Demonstration :

Steps	Pictures	Instructions	Remarks
1		Items to prepare: light source, heat dispersion tape, heat dispersion plate, screwdriver, screws, nuts, washers, and R terminal wires.	Screws, nuts, and washers may be required to firmly attach the heat dispersion module in its fixed position.
2		Attach the heat dispersion tape on the heat dispersion plate at its fixed and locked position.	Heat dispersing paste may be applied to the back of the light source.
3		Attach the light source to the heat dispersion plate.	
4		<ol style="list-style-type: none"> <li>1. Connect all R terminal wires to the heat dispersion plate.</li> <li>2. Evenly tighten all screws.</li> </ol>	Failure is possible if force is applied to improperly positioned screws.

佰鴻工業股份有限公司

Notes:

1. A Components bag is included : R Terminal with 50cm red wire×1、R Terminal with 50cm black wire×1、Insulating WashersX4、M3 ScrewsX4、M2 ScrewsX6.

<http://www.brtled.com>

● Packing(unit: mm[in]):

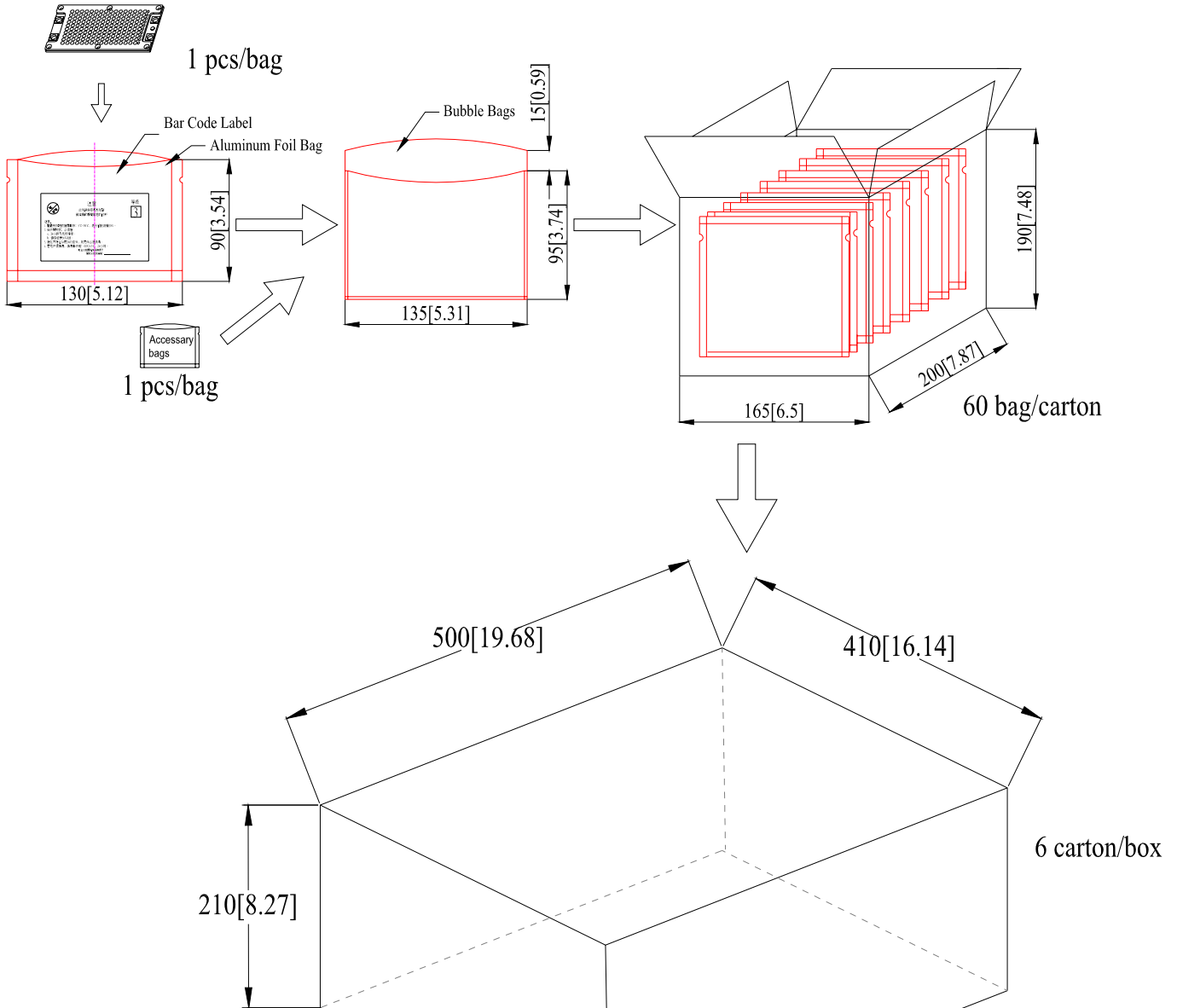

佰鴻工業股份有限公司

<http://www.brtled.com>

Notes:

1. Dimension : mm[in].
2. Tolerance : ±10[0.4]mm[in].

● Total Flux Bin Limits (at  $I_F = 320\text{mA}$ )

BIN CODE	Min. (lm)	Max. (lm)
X	600	759
Y	759	987
Z	987	1283

Tolerance for each Bin limit is  $\pm 15\%$

● Color Temperature Bin Limits (at  $I_F = 320\text{mA}$ )

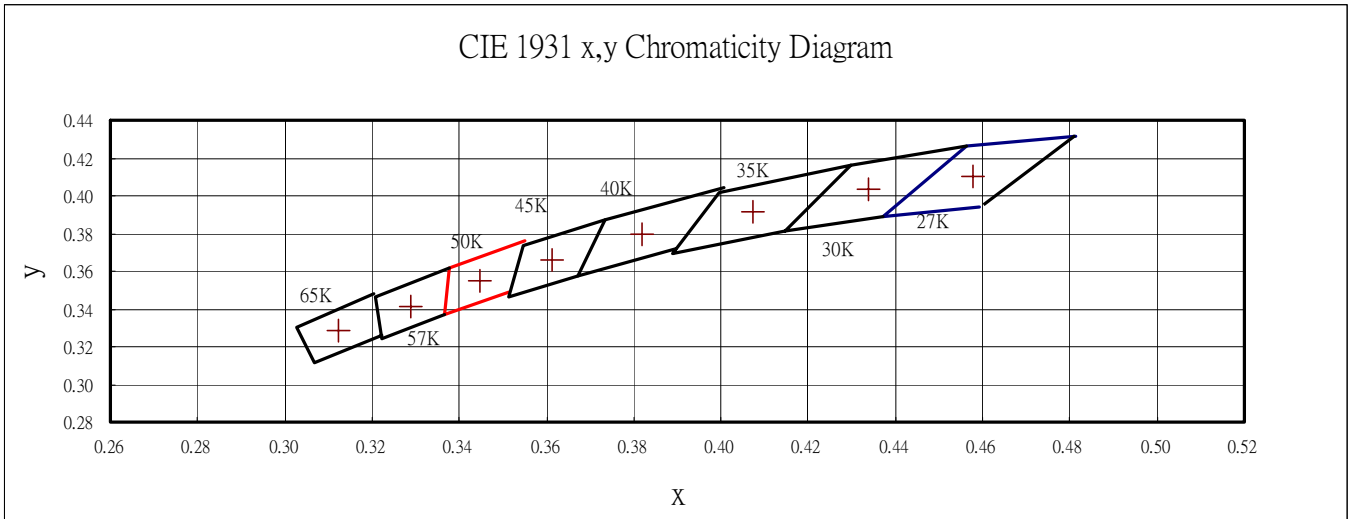

BIN CODE	Nominal CCT	CCT Range	Chromaticity Coordinates				
			x	y	x	y	
K50	5000K	4746-5310	x	0.3447	0.3551	0.3376	0.3366
			y	0.3553	0.3760	0.3616	0.3369

● BIN :  $\frac{x}{x}$   $\frac{x}{x}$



Notes:

- Bin categories are established for classification of products.  
Products may not be available in all bin categories.

<http://www.brtled.com>